

# DENON

Control Dock for iPod®

# ASD-51W

Owner's Manual  
Bedienungsanleitung  
Manuel de l'Utilisateur  
Manuale delle istruzioni  
Manual del usuario  
Gebruiksaanwijzing  
Bruksanvisning



iPod is a trademark of Apple Inc., registered in the U.S. and other countries.

## **GUI** *Graphical User Interface*

English

GUI Menu Operations (👉 page 9)

GUI Menu Map (👉 page 9)

Deutsch

GUI-Menübedienung (👉 Seite 9)

GUI-Menüplan (👉 Seite 9)

Français

Fonctionnement du menu de l'interface graphique GUI (👉 page 9)

Plan du menu de l'interface graphique GUI (👉 page 9)

Italiano

Operazioni menu GUI (👉 pagina 9)

Mappa menu GUI (👉 pagina 9)

Español

Uso de los menús GUI (👉 página 9)

Estructura de los menús GUI (👉 página 9)

Nederlands

Het GUI menu bedienen (👉 blz. 9)

Overzicht van het GUI menu (👉 blz. 9)

Svenska

Användning av GUI-menyer  
(👉 sidan 9)

GUI-menyöversikt (👉 sidan 9)

# IMPORTANT SAFETY INSTRUCTIONS

1. Read these instructions.
2. Keep these instructions.
3. Heed all warnings.
4. Follow all instructions.
5. Do not use this apparatus near water.
6. Clean only with dry cloth.
7. Do not block any ventilation openings.  
Install in accordance with the manufacturer's instructions.
8. Do not install near any heat sources such as radiators, heat registers, stoves, or other apparatus (including amplifiers) that produce heat.
9. Protect the power cord from being walked on or pinched particularly at plugs, convenience receptacles, and the point where they exit from the apparatus.
10. Only use attachments/accessories specified by the manufacturer.
11. Use only with the cart, stand, tripod, bracket, or table specified by the manufacturer, or sold with the apparatus.  
When a cart is used, use caution when moving the cart/apparatus combination to avoid injury from tip-over.
12. Unplug this apparatus during lightning storms or when unused for long periods of time.
13. Refer all servicing to qualified service personnel. Servicing is required when the apparatus has been damaged in any way, such as power-supply cord or plug is damaged, liquid has been spilled or objects have fallen into the apparatus, the apparatus has been exposed to rain or moisture, does not operate normally, or has been dropped.
14. Batteries shall not be exposed to excessive heat such as sunshine, fire or the like.



## CAUTION:

To completely disconnect this product from the mains, disconnect the plug from the wall socket outlet.

The mains plug is used to completely interrupt the power supply to the unit and must be within easy access by the user.

## VORSICHT:

Um dieses Gerät vollständig von der Stromversorgung abzutrennen, ziehen Sie bitte den Stecker aus der Wandsteckdose.

Der Netzstecker wird verwendet, um die Stromversorgung zum Gerät völlig zu unterbrechen; er muss für den Benutzer gut und einfach zu erreichen sein.

## PRECAUTION:

Pour déconnecter complètement ce produit du courant secteur, débranchez la prise de la prise murale.

La prise secteur est utilisée pour couper complètement l'alimentation de l'appareil et l'utilisateur doit pouvoir y accéder facilement.

## ATTENZIONE:

Per scollegare completamente questo prodotto dalla rete di alimentazione elettrica, scollegare la spina dalla relativa presa a muro.

La spina di rete viene utilizzata per interrompere completamente l'alimentazione all'unità e deve essere facilmente accessibile all'utente.

## PRECAUCIÓN:

Para desconectar completamente este producto de la alimentación eléctrica, desconecte el enchufe del enchufe de la pared.

El enchufe de la alimentación eléctrica se utiliza para interrumpir por completo el suministro de alimentación eléctrica a la unidad y debe de encontrarse en un lugar al que el usuario tenga fácil acceso.

## WAARSCHUWING:

Om de voeding van dit product volledig te onderbreken moet de stekker uit het stopcontact worden getrokken.

De netstekker wordt gebruikt om de stroomtoevoer naar het toestel volledig te onderbreken en moet voor de gebruiker gemakkelijk bereikbaar zijn.

## FÖRSIKTIHETSMÅTT:

Koppla loss stickproppen från eluttaget för att helt skilja produkten från nätet. Stickproppen används för att helt bryta strömförsörjningen till apparaten, och den måste vara lättillgänglig för användaren.

**FCC Information (For US customers)**

**1. COMPLIANCE INFORMATION**  
**Product Name: Control Dock for iPod**  
**Model Number: ASD-51W**  
**This product contains FCC ID: P PQ- NM100BB.**

This product complies with Part 15 of the FCC Rules. Operation is subject to the following two conditions: (1 ) this product may not cause harmful interference, and (2) this product must accept any interference received, including interference that may cause undesired operation.

Denon Electronics (USA), LLC  
 100 Corporate Drive, Marwah, NJ 07430-2041  
 Tel. 201-762-6500 (Main)

**2. IMPORTANT NOTICE: DO NOT MODIFY THIS PRODUCT**  
 This product, when installed as indicated in the instructions contained in this manual, meets FCC requirements. Modification not expressly approved by DENON may void your authority, granted by the FCC, to use the product.

**3. CAUTION**

- To comply with FCC RF exposure compliance requirement, separation distance of at least 20 cm must be maintained between the antenna of this product and all persons.
- This product and its antenna must not be co-located or operating in conjunction with any other antenna or transmitter.

**4. NOTE**  
 This product has been tested and found to comply with the limits for a Class B digital device, pursuant to Part 15 of the FCC Rules. These limits are designed to provide reasonable protection against harmful interference in a residential installation.  
 This product generates, uses and can radiate radio frequency energy and, if not installed and used in accordance with the instructions, may cause harmful interference to radio communications. However, there is no guarantee that interference will not occur in a particular installation. If this product does cause harmful interference to radio or television reception, which can be determined by turning the product OFF and ON, the user is encouraged to try to correct the interference by one or more of the following measures:

- Reorient or relocate the receiving antenna.
- Increase the separation between the equipment and receiver.
- Connect the product into an outlet on a circuit different from that to which the receiver is connected.
- Consult the local retailer authorized to distribute this type of product or an experienced radio/TV technician for help.

**IC Information (For Canadian customers)**

**1. PRODUCT**  
**This product contains IC 4491A-NM100BB.**  
 This product complies with RSS-210 of Industry Canada. Operation is subject to the following two conditions: (1) this product may not cause harmful interference, and (2) this product must accept any interference received, including interference that may cause undesired operation.  
 This Class B digital apparatus complies with Canadian ICES-003.

**APPAREIL**  
**Cet appareil contient IC 4491A-NM100BB.**  
 Cet appareil est conforme à la norme CNR-210 du Canada. L'utilisation de ce dispositif est autorisée seulement aux deux conditions suivantes : (1) il ne doit pas produire de brouillage, et (2) l'utilisateur du dispositif doit être prêt à accepter tout brouillage radioélectrique reçu, même si ce brouillage est susceptible de compromettre le fonctionnement du dispositif.  
 Cet appareil numérique de la classe B est conforme à la norme NMB-003 du Canada.

**2. CAUTION**  
 To reduce potential radio interference to other users, the antenna type and its gain should be so chosen that the equivalent isotropically radiated power (e.i.r.p.) is not more than that permitted for successful communication.

**ATTENTION**  
 Afin de réduire le risque d'interférence aux autres utilisateurs, il faut choisir le type d'antenne et son gain de façon à ce que la puissance isotrope rayonnée équivalente (p.i.r.e.) ne soit pas supérieure au niveau requis pour l'obtention d'une communication satisfaisante.

**CE**  **R&TTE Directive 1999/5/EC**

This product may be operated in the following countries;

AT	BE	CZ	DK	FI
FR	DE	GR	HU	IE
IT	NL	PL	PT	SK
ES	SE	GB	NO	CH

### • DECLARATION OF CONFORMITY

Hereby, D&M Holdings Inc., Denon Brand Company declares that this product ASD-51W is in compliance with the essential requirements and other relevant provisions of Directive 1999/5/EC, in conformity with the following standards; EN60950, EN55013, EN55020, EN55022, EN55024, EN61000-3-2, EN61000-3-3, EN300328, EN301489-01, EN301489-17 and EN50385

The declaration of conformity may be consulted to our European representative, DENON Europe.

### • ÜBEREINSTIMMUNGSERKLÄRUNG

Hiermit erklärt D&M Holdings Inc., Denon Brand Company, dass sich das Gerät ASD-51W in Übereinstimmung mit den grundlegenden Anforderungen und den übrigen einschlägigen Bestimmungen der Richtlinie 1999/5/EG befindet, den folgenden Standards entspricht:

EN60950, EN55013, EN55020, EN55022, EN55024, EN61000-3-2, EN61000-3-3, EN300328, EN301489-01, EN301489-17 und EN50385

Wenden Sie sich bei Fragen zur Konformitätserklärung an unseren europäischen Vertreter, DENON Europe.

### • DECLARATION DE CONFORMITE

Par la présente, D&M Holdings Inc., Denon Brand Company déclare que l'appareil ASD-51W est conforme aux exigences essentielles et aux autres dispositions pertinentes de la directive 1999/5/CE, e conforme alle seguenti normative:

EN60950, EN55013, EN55020, EN55022, EN55024, EN61000-3-2, EN61000-3-3, EN300328, EN301489-01, EN301489-17 e EN50385.

La déclaration de conformité pourra être consultée auprès de notre représentant en Europe, DENON Europe.

### • DICHIARAZIONE DI CONFORMITÀ

Con la presente D&M Holdings Inc., Denon Brand Company dichiara che questo ASD-51W è conforme ai requisiti essenziali ed alle altre disposizioni pertinenti stabilite dalla direttiva 1999/5/CE, e conforme alle seguenti normative:

EN60950, EN55013, EN55020, EN55022, EN55024, EN61000-3-2, EN61000-3-3, EN300328, EN301489-01, EN301489-17 e EN50385.

La dichiarazione di conformità può essere consultata presso il nostro rappresentante europeo, DENON Europe.

QUESTO PRODOTTO E' CONFORME

AL D.M. 28/08/95 N. 548

### • DECLARACIÓN DE CONFORMIDAD

Por la presente, D&M Holdings Inc., Denon Brand Company, declara que este ASD-51W cumple con los requisitos esenciales y otras exigencias relevantes de la Directiva 1999/5/EC, esta conforme con los siguientes estandares:

EN60950, EN55013, EN55020, EN55022, EN55024, EN61000-3-2, EN61000-3-3, EN300328, EN301489-01, EN301489-17 y EN50385.

Puede consultar a nuestro representante europeo, DENON Europe, acerca de la declaración de conformidad.

### • EENVORMIGHEIDSVERKLARING

Hierbij verklaart D&M Holdings Inc., Denon Brand Company dat het toestel ASD-51W in overeenstemming is met de essentiële eisen en de andere relevante bepalingen van richtlijn 1999/5/EG, in overeenstemming is met de volgende normen:

EN60950, EN55013, EN55020, EN55022, EN55024, EN61000-3-2, EN61000-3-3, EN300328, EN301489-01, EN301489-17 en EN50385.

De eenvormigheidsverklaring mag worden geconsulteerd aan onze Europese vertegenwoordiger, DENON Europa.

### • ÖVERENSSTÄMMELSESINTYG

Denna utrustning är i överensstämmelse med de väsentliga kraven och andra relevanta bestämmelser i Direktiv 1999/5/EC, uppfyller följande standarder:

EN60950, EN55013, EN55020, EN55022, EN55024, EN61000-3-2, EN61000-3-3, EN300328, EN301489-01, EN301489-17 och EN50385.

EU-konformitetsintyget kan på begäran fås från DENON Europe, vår representant i Europa.

DENON EUROPE  
Division of D&M Germany GmbH  
An der Landwehr 19, Nettetal,  
D-41334 Germany

**CAUTION:**

- The ventilation should not be impeded by covering the ventilation openings with items, such as newspapers, tablecloths, curtains, etc.
- No naked flame sources, such as lighted candles, should be placed on the unit.
- Observe and follow local regulations regarding battery disposal.
- Do not expose the unit to dripping or splashing fluids.
- Do not place objects filled with liquids, such as vases, on the unit.

**ACHTUNG:**

- Die Belüftung sollte auf keinen Fall durch das Abdecken der Belüftungsöffnungen durch Gegenstände wie beispielsweise Zeitungen, Tischtücher, Vorhänge o. Ä. behindert werden.
- Auf dem Gerät sollten keinerlei direkte Feuerquellen wie beispielsweise angezündete Kerzen aufgestellt werden.
- Bitte beachten Sie bei der Entsorgung der Batterien die örtlich geltenden Umweltbestimmungen.
- Das Gerät sollte keiner tropfenden oder spritzenden Flüssigkeit ausgesetzt werden.
- Auf dem Gerät sollten keine mit Flüssigkeit gefüllten Behälter wie beispielsweise Vasen aufgestellt werden.

**ATTENTION:**

- La ventilation ne doit pas être gênée en recouvrant les ouvertures de la ventilation avec des objets tels que journaux, rideaux, tissus, etc.
- Aucune flamme nue, par exemple une bougie, ne doit être placée sur l'appareil.
- Veillez à respecter les lois en vigueur lorsque vous jetez les piles usagées.
- L'appareil ne doit pas être exposé à l'eau ou à l'humidité.
- Ne pas poser d'objet contenant du liquide, par exemple un vase, sur l'appareil.

**ATTENZIONE:**

- Le aperture di ventilazione non devono essere ostruite coprendole con oggetti, quali giornali, tovaglie, tende e così via.
- Non posizionate sull'unità fiamme libere, come ad esempio candele accese.
- Prestate attenzione agli aspetti legati alla tutela dell'ambiente nello smaltimento delle batterie.
- L'apparecchiatura non deve essere esposta a gocciolii o spruzzi.
- Non posizionate sull'unità alcun oggetto contenente liquidi, come ad esempio i vasi.

**PRECAUCIÓN:**

- La ventilación no debe quedar obstruida por haberse cubierto las aperturas con objetos como periódicos, manteles, cortinas, etc.
- No debe colocarse sobre el aparato ninguna fuente inflamable sin protección, como velas encendidas.
- A la hora de deshacerse de las pilas, respete la normativa para el cuidado del medio ambiente.
- No exponer el aparato al goteo o salpicaduras cuando se utilice.
- No colocar sobre el aparato objetos llenos de líquido, como jarros.

**WAARSCHUWING:**

- De ventilatie mag niet worden belemmerd door de ventilatieopeningen af te dekken met bijvoorbeeld kranten, een tafelkleed, gordijnen, enz.
- Plaats geen open vlammen, bijvoorbeeld een brandende kaars, op het apparaat.
- Houd u steeds aan de milieuvoorschriften wanneer u gebruikte batterijen wegdoet.
- Stel het apparaat niet bloot aan druppels of spatten.
- Plaats geen voorwerpen gevuld met water, bijvoorbeeld een vaas, op het apparaat.

**OBSERVERA:**

- Ventilationen bör inte förhindras genom att täcka för ventilationsöppningarna med föremål såsom tidningar, bordsdukar, gardiner osv.
- Inga blottade brandkällor, såsom tända ljus, får placeras på apparaten.
- Tänk på miljöaspekterna när du bortskaffar batterier.
- Apparaten får inte utsättas för vätska.
- Placera inte föremål fyllda med vätska, t.ex. vaser, på apparaten.

**NOTE ON USE**

- Avoid high temperatures.  
Allow for sufficient heat dispersion when installed in a rack.
- Handle the power cord carefully.  
Hold the plug when unplugging the cord.
- Keep the unit free from moisture, water, and dust.
- Unplug the power cord when not using the unit for long periods of time.
- Do not obstruct the ventilation holes.
- Do not let foreign objects into the unit.
- Do not let insecticides, benzene, and thinner come in contact with the unit.
- Never disassemble or modify the unit in any way.

**HINWEISE ZUM GEBRAUCH**

- Vermeiden Sie hohe Temperaturen.  
Beachten Sie, dass eine ausreichende Belüftung gewährleistet wird, wenn das Gerät auf ein Regal gestellt wird.
- Gehen Sie vorsichtig mit dem Netzkabel um.  
Halten Sie das Kabel am Stecker, wenn Sie den Stecker herausziehen.
- Halten Sie das Gerät von Feuchtigkeit, Wasser und Staub fern.
- Wenn das Gerät längere Zeit nicht verwendet werden soll, trennen Sie das Netzkabel vom Netzstecker.
- Decken Sie den Lüftungsbereich nicht ab.
- Lassen Sie keine fremden Gegenstände in das Gerät kommen.
- Lassen Sie das Gerät nicht mit Insektiziden, Benzin oder Verdünnungsmitteln in Berührung kommen.
- Versuchen Sie niemals das Gerät auseinander zu nehmen oder zu verändern.

**OBSERVATIONS RELATIVES A L'UTILISATION**

- Eviter des températures élevées.  
Tenir compte d'une dispersion de chaleur suffisante lors de l'installation sur une étagère.
- Manipuler le cordon d'alimentation avec précaution.  
Tenir la prise lors du débranchement du cordon.
- Protéger l'appareil contre l'humidité, l'eau et la poussière.
- Débrancher le cordon d'alimentation lorsque l'appareil n'est pas utilisé pendant de longues périodes.
- Ne pas obstruer les trous d'aération.
- Ne pas laisser des objets étrangers dans l'appareil.
- Ne pas mettre en contact des insecticides, du benzène et un diluant avec l'appareil.
- Ne jamais démonter ou modifier l'appareil d'une manière ou d'une autre.

**NOTE SULL'USO**

- Evitate di esporre l'unità a temperature elevate.  
Assicuratevi che vi sia un'adeguata dispersione del calore quando installate l'unità in un mobile per componenti audio.
- Maneggiate il cavo di alimentazione con attenzione.  
Tenete ferma la spina quando scollegate il cavo dalla presa.
- Tenete l'unità lontana dall'umidità, dall'acqua e dalla polvere.
- Scollegate il cavo di alimentazione quando prevedete di non utilizzare l'unità per un lungo periodo di tempo.
- Non coprite i fori di ventilazione.
- Non inserite corpi estranei all'interno dell'unità.
- Assicuratevi che l'unità non entri in contatto con insetticidi, benzolo o solventi.
- Non smontate né modificate l'unità in alcun modo.

**NOTAS SOBRE EL USO**

- Evite altas temperaturas.  
Permite la suficiente dispersión del calor cuando está instalado en la consola.
- Maneje el cordón de energía con cuidado.  
Sostenga el enchufe cuando desconecte el cordón de energía.
- Mantenga el equipo libre de humedad, agua y polvo.
- Desconecte el cordón de energía cuando no utilice el equipo por mucho tiempo.
- No obstruya los orificios de ventilación.
- No deje objetos extraños dentro del equipo.
- No permita el contacto de insecticidas, gasolina y diluyentes con el equipo.
- Nunca desarme o modifique el equipo de ninguna manera.

**ALVORENSTE GEBRUIKEN**

- Vermijd hoge temperaturen.  
Zorg er bij installatie in een audiorack voor, dat de door het toestel geproduceerde warmte goed kan worden afgevoerd.
- Hanteer het netsnoer voorzichtig.  
Houd het snoer bij de stekker vast wanneer deze moet worden aan- of losgekoppeld.
- Laat geen vochtigheid, water of stof in het apparaat binnendringen.
- Neem altijd het netsnoer uit het stopcontact wanneer het apparaat gedurende een lange periode niet wordt gebruikt.
- De ventilatieopeningen mogen niet worden beblokkeerd.
- Laat geen vreemde voorwerpen in dit apparaat vallen.
- Voorkom dat insecticiden, benzene of verfverdunder met dit toestel in contact komen.
- Dit toestel mag niet gedemonteerd of aangepast worden.

**OBSERVERA ANGÅENDE ANVÄNDNINGEN**

- Undvik höga temperaturer.  
Se till att det finns möjlighet till god värmeavledning vid montering i ett rack.
- Hantera nätkablen varsamt.  
Håll i kablarna när den kopplas från el-uttaget.
- Utsätt inte apparaten för fukt, vatten och damm.
- Koppla loss nätkablarna om apparaten inte kommer att användas i lång tid.
- Tapp inte till ventilationsöppningarna.
- Se till att främmande föremål inte tränger in i apparaten.
- Se till att inte insektsmedel på spraybruk, bensen och thinner kommer i kontakt med apparatens hölje.
- Ta inte isär apparaten och försök inte bygga om den.

**A NOTE ABOUT RECYCLING:**

This product's packaging materials are recyclable and can be reused. Please dispose of any materials in accordance with the local recycling regulations.

When discarding the unit, comply with local rules or regulations. Batteries should never be thrown away or incinerated but disposed of in accordance with the local regulations concerning battery disposal.

This product and the supplied accessories, excluding the batteries, constitute the applicable product according to the WEEE directive.

**HINWEIS ZUM RECYCLING:**

Das Verpackungsmaterial dieses Produktes ist zum Recyceln geeignet und kann wieder verwendet werden. Bitte entsorgen Sie alle Materialien entsprechend der örtlichen Recycling-Vorschriften.

Beachten Sie bei der Entsorgung des Gerätes die örtlichen Vorschriften und Bestimmungen.

Die Batterien dürfen nicht in den Hausmüll geworfen oder verbrannt werden; bitte entsorgen Sie die Batterien gemäß der örtlichen Vorschriften.

Dieses Produkt und das im Lieferumfang enthaltene Zubehör (mit Ausnahme der Batterien!) entsprechen der WEEE-Direktive.

**UNE REMARQUE CONCERNANT LE RECYCLAGE:**

Les matériaux d'emballage de ce produit sont recyclables et peuvent être réutilisés. Veuillez disposer des matériaux conformément aux lois sur le recyclage en vigueur.

Lorsque vous mettez cet appareil au rebut, respectez les lois ou réglementations en vigueur.

Les piles ne doivent jamais être jetées ou incinérées, mais mises au rebut conformément aux lois en vigueur sur la mise au rebut des piles.

Ce produit et les accessoires inclus, à l'exception des piles, sont des produits conformes à la directive DEEE.

**NOTA RELATIVA AL RICICLAGGIO:**

I materiali di imballaggio di questo prodotto sono riutilizzabili e riciclabili. Smaltire i materiali conformemente alle normative locali sul riciclaggio.

Per lo smaltimento dell'unità, osservare le normative o le leggi locali in vigore.

Non gettare le batterie, né incenerirle, ma smaltirle conformemente alla normativa locale sui rifiuti chimici.

Questo prodotto e gli accessori inclusi nell'imballaggio sono applicabili alla direttiva RAEE, ad eccezione delle batterie.



Pb

**ACERCA DEL RECICLAJE:**

Los materiales de embalaje de este producto son reciclables y se pueden volver a utilizar. Disponga de estos materiales siguiendo los reglamentos de reciclaje de su localidad.

Cuando se deshaga de la unidad, cumpla con las reglas o reglamentos locales. Las pilas nunca deberán tirarse ni incinerarse. Deberá disponer de ellas siguiendo los reglamentos de su localidad relacionados con los desperdicios químicos.

Este producto junto con los accesorios empaquetados es el producto aplicable a la directiva RAEE excepto pilas.

**EEN AANTEKENING MET BETREKKING TOT DE RECYCLING:**

Het inpakmateriaal van dit product is recycleerbaar en kan opnieuw gebruikt worden. Er wordt verzocht om zich van elk afvalmateriaal te ontdoen volgens de plaatselijke voorschriften.

Volg voor het wegdoen van de speler de voorschriften voor de verwijdering van wit- en bruingoed op.

Batterijen mogen nooit worden weggegooid of verbrand, maar moeten volgens de plaatselijke voorschriften betreffende chemisch afval worden verwijderd.

Op dit product en de meegeleverde accessoires, m.u.v. de batterijen is de richtlijn voor afgedankte elektrische en elektronische apparaten (WEEE) van toepassing.

**OBSERVERA ANGÅENDE ÅTERTVINNING:**

Produktens emballage är återvinningsbart och kan återvändas. Kassera det enligt lokala återvinningsbestämmelser.

När du kasserar enheten ska du göra det i överensstämmelse med lokala regler och bestämmelser.

Batterier får absolut inte kastas i soporna eller brännas. Kassera dem enligt lokala bestämmelser för kemiskt avfall.

Denna apparat och de tillbehör som levereras med den uppfyller gällande WEEE-direktiv, med undantag av batterierna.

**1. IMPORTANT NOTICE: DO NOT MODIFY THIS PRODUCT**

This product, when installed as indicated in the instructions contained in this manual, meets R&TTE directive requirements. Modification of the product could result in hazardous Radio and EMC radiation.

**2. CAUTION**

- Separation distance of at least 20 cm must be maintained between the antenna of this product and all persons.
- This product and its antenna must not be co-located or operating in conjunction with any other antenna or transmitter.

**1. WICHTIGER HINWEIS: NEHMEN SIE KEINE VERÄNDERUNGEN AN DIESEM PRODUKT VOR**

Wenn dieses Produkt entsprechend dieser Bedienungsanleitung aufgebaut wird, entspricht es den Anforderungen der R&TTE-Richtlinie. Veränderungen am Produkt können zu gefährlicher Funk- und EMV-Strahlung führen.

**2. VORSICHT**

- Zwischen der Antenne dieses Produkts und Personen muss ein Schutzabstand von 20 cm eingehalten werden.
- Dieses Produkt und seine Antenne dürfen nicht neben anderen Antennen oder Sendern aufgestellt oder zusammen mit ihnen verwendet werden.

**1. MISE EN GARDE IMPORTANTE : NE JAMAIS MODIFIER CE PRODUIT**

Si toutes les consignes indiquées dans ce mode ont été respectées pendant son installation, ce produit est conforme aux directives R&TTE. Toute modification du produit risquerait alors de générer des radiations radio et EMC dangereuses.

**2. ATTENTION**

- L'antenne de l'appareil devra être située à une distance de 20 cm au moins des personnes.
- Ce produit ainsi que son antenne ne devront en aucun cas être utilisés à proximité d'une autre antenne ou transmetteur.

**1. AVVERTENZA IMPORTANTE: NON MODIFICARE QUESTO PRODOTTO**

Se installato come indicato nelle istruzioni del presente manuale, questo prodotto soddisfa i requisiti della direttiva R&TTE. Eventuali modifiche apportate al prodotto potrebbero causare pericolose radiazioni radio ed EMC.

**2. ATTENZIONE**

- È necessario mantenere una distanza minima di 20 cm tra l'antenna di questo prodotto e le persone.
- Questo prodotto e la relativa antenna non devono essere posizionati in prossimità di altre antenne o trasmettitori e non devono essere utilizzati congiuntamente a questi ultimi.

**1. NOTA IMPORTANTE: NO MODIFIQUE ESTE PRODUCTO**

Este producto, si es instalado de acuerdo con las instrucciones contenidas en este manual, cumple los requisitos de la directiva R&TTE. La modificación del producto puede producir radiación de Radio y EMC peligrosa.

**2. PRECAUCIÓN**

- Se debe mantener una separación de al menos 20 cm entre la antena del producto y las personas.
- Este producto y su antena no debe instalarse ni utilizarse conjuntamente con otra antena o transmisor.

**1. BELANGRIJKE MEDEDELING: BRENG AAN DIT PRODUCT GEEN AANPASSINGEN AAN**

Dit product, indien geïnstalleerd volgens de aanwijzingen in deze gebruiksaanwijzing, voldoet aan de vereisten van de R&TTE-richtlijn. Aanpassing van dit product kan gevaarlijke radio- en EMC-straling tot gevolg hebben.

**2. LET OP**

- Houd tussen antenne en personen altijd een afstand van tenminste 20 cm aan.
- Dit product en zijn antenne mogen niet in de buurt van een andere antenne of zender worden geplaatst of in combinatie daarmee worden gebruikt.

**1. VIKTIGT: APPARATEN FÅR INTE MODIFIERAS**

Under förutsättning att apparaten installeras enligt anvisningarna i denna bruksanvisning, uppfyller denna kraven i R&TTE-direktivet. Ev. modifiering av apparaten kan resultera i farlig radio- och elektromagnetisk strålning.

**2. FÖRSIKTIGT**

- Se till att det finns ett avstånd på minst 20 cm mellan apparatens antenn och personer i omgivningen.
- Apparaten och dess antenn får inte placeras eller användas i närheten av andra antenner eller sändare.



## □ Contents

### Getting Started

<b>Accessories</b> .....	2
<b>Cautions on Handling</b> .....	2
<b>Operations Enabled with the ASD-51W</b> .....	2
<b>About the Remote Control Unit</b> .....	3
Before Using .....	3
Inserting the Battery .....	3
Operating Range of the Remote Control Unit .....	3
<b>Part Names and Functions</b> .....	4
Top Panel / Front Panel / Side Panel .....	4
Rear Panel .....	4
Remote Control Unit .....	5

### Connections

<b>Mounting the universal adapter on the control dock</b> .....	5
<b>Supported iPods/iPod compatibles</b> .....	5
<b>Connection to devices equipped with Dock Control</b> .....	6
<b>Connecting to a Home Network (LAN)</b> .....	7

### Settings

<b>GUI Menu Map</b> .....	9
<b>GUI Menu Operations</b> .....	9
Example of the Display of the GUI Mark at a Title .....	9
Examples of GUI Screen Displays .....	10
<b>Making Detailed Settings (Setup)</b> .....	11

### Playback

<b>iPod® Playback</b> .....	19
Preparations .....	19
Playback Music and Video .....	19
Viewing Still Pictures on the iPod .....	20
<b>Playing Network Audio</b> .....	20
About the Internet Radio Function .....	20
Listening to Internet Radio .....	22
Registering Internet Radio Stations as Your Favorites .....	22
Playing Files Stored on a Computer .....	23
Listening to Napster .....	24
Listening to Rhapsody (for North America model only) .....	26
<b>Convenient Functions</b> .....	28
Operating a Wireless LAN-Compatible Mobile Terminal to Play Music .....	28
Playing the Same Network Audio on Different Devices Connected in a Network (Party Mode Function) .....	30
Operating the ASD-51W with a Browser (Web Control Function) .....	31

### Other Information

<b>About Networks</b> .....	32
Windows Media Player Ver.11 .....	32
vTuner .....	32
DLNA .....	32
Windows Media DRM .....	32
About Wireless LAN .....	32

### Troubleshooting .....

<b>Restart and Reset Operations</b> .....	37
---	----

### Specifications .....

## Getting Started

Thank you for purchasing this DENON product. To ensure proper operation, please read these owner's manual carefully before using the product. After reading them, be sure to keep them for future reference.

### Accessories

Check that the following parts are supplied with the product.

①	Owner's manual.....	1
②	"WPS" Wi-Fi Setup Guide .....	1
③	Warranty (for North America model only) .....	1
④	Service station list .....	1
⑤	AC Adapter (KSAFC0600150W1UV-1).....	1
⑥	Remote control (RC-1137).....	1
⑦	AV/Control Cable (Cable length: Approx. 6.6 ft / 2 m) .....	1
⑧	Rod antenna for wireless LAN connection .....	1

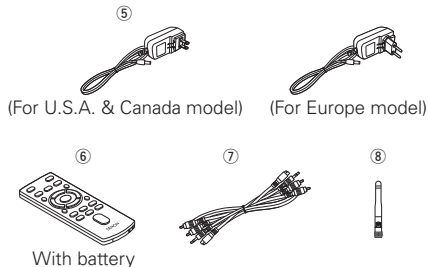

#### NOTE

- Do not use any AC adapter other than the specified one. Doing so could result in fires or electric shock.
- The included AC adapter is exclusively for use with this unit. Never use it with other equipment.

### Cautions on Handling

#### • Before turning the power switch on

Check once again that all connections are correct and that there are no problems with the connection cables.

- Power is supplied to some of the circuitry even when the unit is set to the standby mode. When traveling or leaving home for long periods of time, be sure to unplug the power cord from the power outlet.

#### • Cautions on using mobile phones

Using a mobile phone near this unit may result in noise. If so, move the mobile phone away from this unit when using it.

#### • Moving the unit

Turn off the power and unplug the power cord from the power outlet. Next, disconnect the connection cables to other system units before moving the unit.

- Note that the illustrations in these instructions may differ from the actual unit for explanation purposes.

### Operations Enabled with the ASD-51W

Play iPod Audio and Video  page 19

Listen to Internet Radio  page 22

#### WPS Setup

 page 13, 14

The WPS function makes it easy to connect to wireless LAN.

#### Play Audio Files stored on a PC (Media Server)

 page 23

#### Play Music from Fee-based Music Sites

Napster  page 24

Rhapsody  page 26  
(for North America model only)

#### Party Mode Function

 page 30

If you use a compatible DENON network product, you can play music simultaneously on up to 5 devices.

#### Operation Using a Mobile device

 page 28

You can play music by operating a wireless LAN-compatible mobile device.

#### Web Control Function (iPod touch only)

 page 31

Using the browser software on an iPod touch, you can operate the ASD-51W via the network.

## About the Remote Control Unit

### Before Using

Remove the insulating sheet before using the remote control unit.

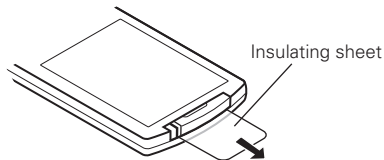

### Inserting the Battery

- ① Remove the rear lid.
- ② Load the battery properly as indicated by the marks in the battery compartment.

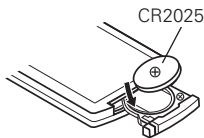
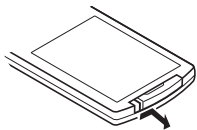

- ③ Put the rear lid back on.

### NOTE

- Replace the battery with new ones if the set does not operate even when the remote control unit is operated close to the unit.
- The supplied battery are only for verifying operation.
- When inserting the battery, be sure to do so in the proper direction, following the “⊕” and “⊖” marks in the battery compartment.
- To prevent damage or leakage of battery fluid: Do not short-circuit, disassemble, heat or dispose of battery in flames.
- If the battery fluid should leak, carefully wipe the fluid off the inside of the battery compartment and insert new battery.
- Remove the battery from the remote control unit if it will not be in use for long periods.
- When replacing the battery, have the new battery ready and insert them as quickly as possible.

### CAUTION

RISK OF EXPLOSION IF BATTERY IS REPLACED BY AN INCORRECT TYPE.  
DISPOSE OF USED BATTERIES ACCORDING TO THE INSTRUCTIONS.

### Operating Range of the Remote Control Unit

Point the remote control unit at the remote sensor when operating it.

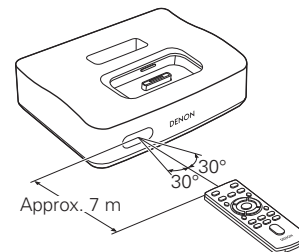

### NOTE

The set may function improperly or the remote control unit may not operate if the remote control sensor is exposed to direct sunlight, strong artificial light from an inverter type fluorescent lamp or infrared light.

## Part Names and Functions

For buttons not explained here, see the page indicated in parentheses ( ).

### Top Panel / Front Panel / Side Panel

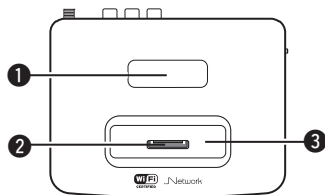

- 1 Remote control unit storage slot
- 2 Dock connector
- 3 Universal adapter slot ..... (5)
- 4 POWER indicator

After inserting the AC adapter plug into the wall socket, turn the power operation switch on the side panel to "ON/STANDBY" to power up the ASD-51W. This indicator then lights up. When the GUI and audio output stops the display is extinguished.

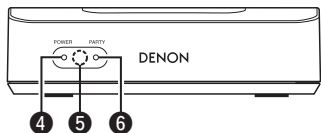

- 5 Remote Control sensor ..... (3)
- 6 PARTY mode indicator ..... (30)
- 7 Power operation switch ..... (6)

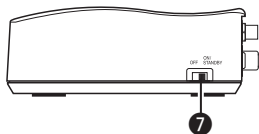

### Rear Panel

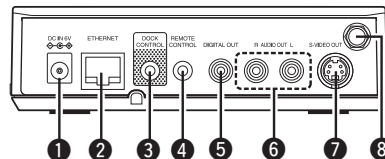

- 1 DC IN connector ..... (6)
- 2 ETHERNET connector ..... (7)
- 3 DOCK CONTROL jack ..... (6)
- 4 REMOTE CONTROL jack ..... (6)
- 5 Digital audio output connector (DIGITAL OUT) ..... (6)
- 6 Analog audio output connectors (AUDIO OUT) ..... (6)
- 7 S-VIDEO output connector ..... (6)
- 8 Wireless antenna terminal ..... (7)

**NOTE**

It is not possible to output audio simultaneously from the digital audio output connector 5 and analog audio output connectors 6. The default setting is for audio to be output from the analog audio output connectors 6. When outputting audio from the digital audio output connector 5, switch the setting to "Digital" in the GUI menu "Setup" - "Audio Output" (page 18).

## Remote Control Unit

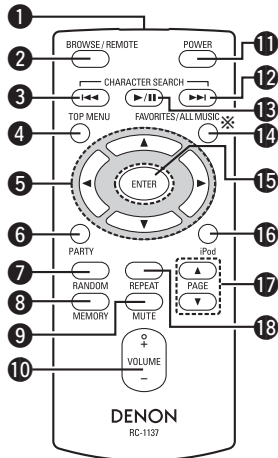

※: **ALL MUSIC** functions are not executed by this unit.

- 1 Remote control signal transmitter ..... (3)
- 2 iPod mode select button (BROWSE/REMOTE) ..... (20)
- 3 CHARACTER SEARCH button (left arrow) ..... (23, 24)
- 4 TOP MENU button ..... (9)  
When pressed, the GUI's top menu appears on the monitor.  
When pressed and held for 3 seconds, the display switches to the WPS setup screen.

- 5 Cursor buttons (up/down/left/right arrows)
- 6 PARTY mode button ..... (30)  
When pressed, "Enter Party Mode?" is displayed.
- 7 RANDOM button
- 8 MEMORY button
- 9 MUTE button  
Turning off the sound temporarily.
- 10 VOLUME control buttons  
Use this to adjust the volume.
- 11 POWER button  
When this button is pressed, the GUI and audio outputs are stopped. Even when stopped (POWER indicator extinguished) the iPod is charged.
- 12 CHARACTER SEARCH button (right arrow) ..... (23, 24)
- 13 Play/Pause button (right arrow with vertical bars)
- 14 FAVORITES button ..... (23)  
When pressed, the favorites folder appears on the monitor.
- 15 ENTER button ..... (9, 19)
- 16 iPod menu button  
When pressed, the iPod menu appears on the monitor.
- 17 PAGE buttons (up/down arrows)
- 18 REPEAT button

## Connections

## Mounting the universal adapter on the control dock

A genuine iPod dock adapter can be mounted on this ASD-51W. To connect an iPod, use the dock adapter included with the iPod.

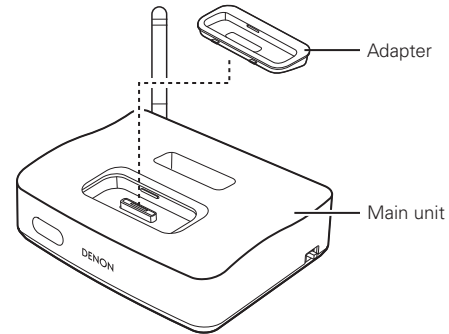

## Supported iPods/iPod compatibles

The ASD-51W supports any iPod equipped with a Dock connector (except the 3rd and 4th generation, iPod mini and iPod Photo).

For latest compatible lists, please visit.

<http://denon.com/asd-51/>

## Connection to devices equipped with Dock Control

The ASD-51W can be operated remotely using the supplied remote control. By connecting to your existing equipment, you can play back your favourite music and video files from your iPod or from over a network.

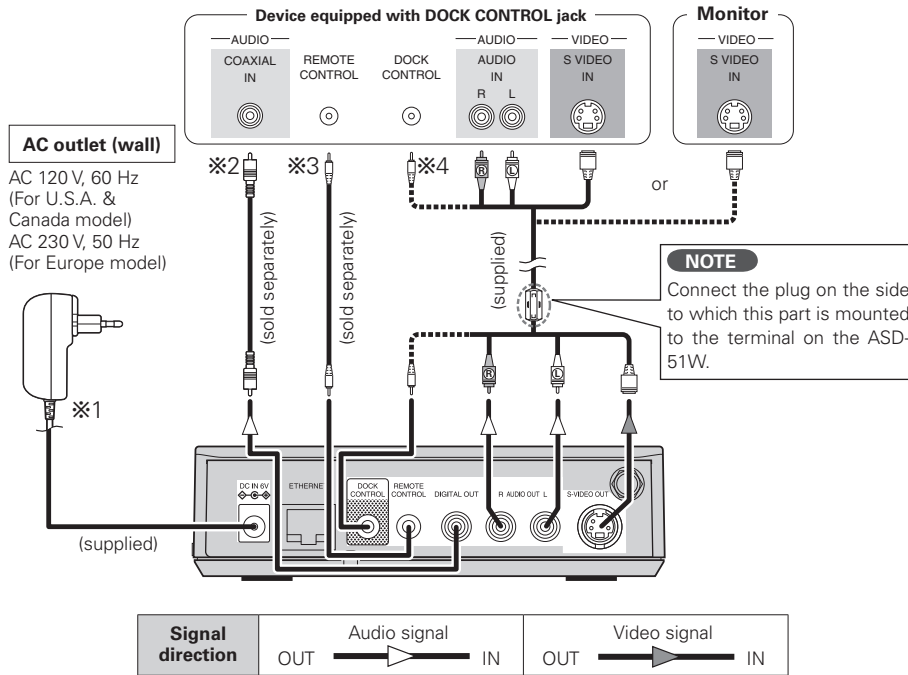

**NOTE**

- When the DOCK CONTROL jack is connected, the ASD-51W no longer accepts remote control commands. To use the remote control unit, point it at the remote control sensor on the connected device when operating it.

- Only connect equipment which is compatible with the DOCK CONTROL jack to the DOCK CONTROL jack of the ASD-51W. Connecting non-compatible equipment will result in a malfunction.

- ※1: After inserting the AC adapter plug into the wall socket, turn the power operation switch on the side panel to "ON/STANDBY" to power up the ASD-51W. The power indicator then lights up, and after 15-20 seconds the GUI screen is displayed on the monitor.
- ※2: Digital connection is possible using a commercially available coaxial digital cable. When using the digital output, you will need to perform settings in the GUI menu "Setup" - "Other" - "Audio Output" (page 18). The default setting is "Analog". Digital output is turned off.

**NOTE**

When making a digital connection to a DENON amplifier released in 2009 or earlier, you should not use the DOCK CONTROL jack.

- ※3: Please use a commercially available monaural mini-plug cable for the connection. Connect to equipment that has a REMOTE CONTROL jack. The ASD-51W receives remote control signals from the connected equipment, and these signals are sent to the equipment to operate it.
- ※4: ASD-51W can be operated from a DENON amplifier or DENON system device equipped with a DOCK CONTROL jack connected to the ASD-51W.

Features may be limited, depending on the device connected.

**NOTE**

When using the DOCK CONTROL jack, be sure to make an analog connection.

Latest compatible lists  
<http://denon.com/asd-51/>

## Connecting to a Home Network (LAN)

When you connect the ASD-51W to a home network, you can enjoy listening to music files stored on your PC, internet radio audio and other sources. You can also control the ASD-51W from your iPod touch via the Web browser.

### [Wired LAN]

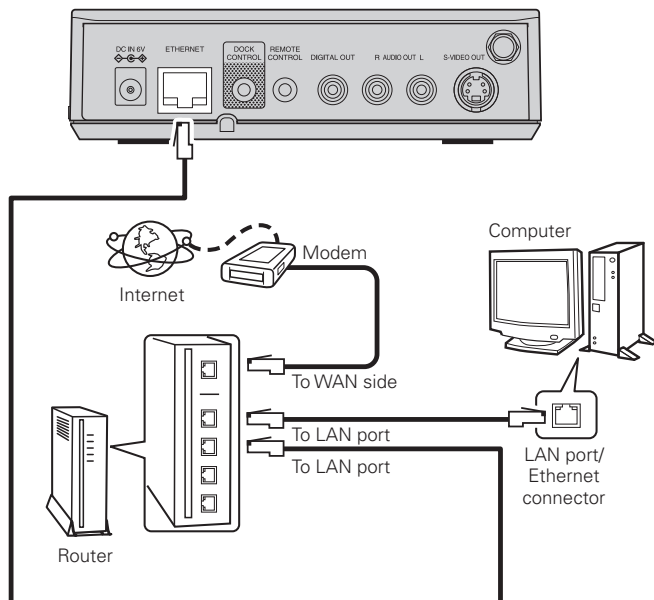

#### NOTE

- It is not possible to use both a wired and wireless LAN at the same time.
- If a wired LAN is connected when the power to the ASD-51W is turned on, it automatically uses wired LAN mode.
  - If a wired LAN is not connected when the power to the ASD-51W is turned on, it automatically uses wireless LAN mode.

### [Wireless LAN]

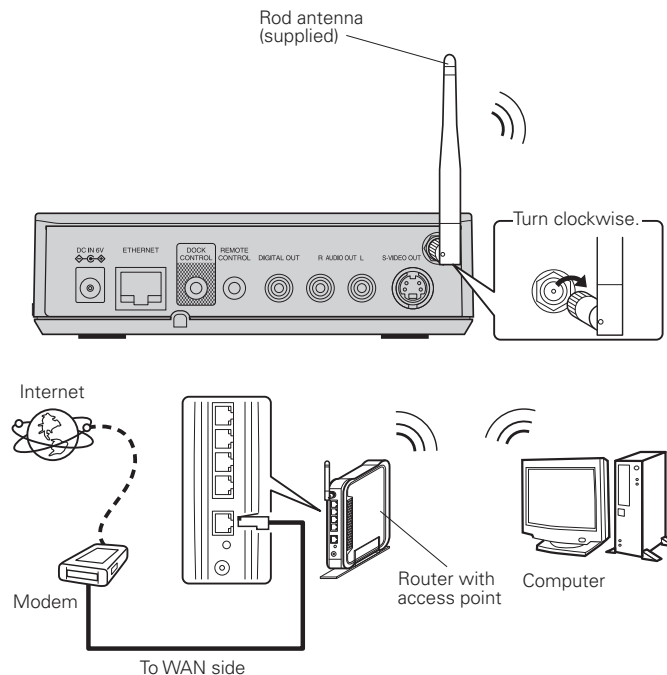

## Connecting to a Home Network (LAN)

**Required system****❑ Broadband Internet connection**

A broadband line connection to the Internet is required in order to use the ASD-51W's Internet radio function and firmware update.

**❑ Modem**

This is a device that is connected to the broadband line to communicate with the Internet. Some are integrated with the router.

**❑ Router**

- When using the ASD-51W, we recommend you use a router equipped with the following functions:
  - Built-in DHCP (Dynamic Host Configuration Protocol) server  
This function automatically assigns IP addresses on the LAN.
  - Built-in 100BASE-TX switch  
When connecting multiple devices, we recommend a switching hub with a speed of 100 Mbps or greater.
- When using with a wireless LAN, prepare a broadband router with built-in access point.

**❑ Ethernet cable (CAT-5 or greater recommended)**

Use for wired LAN.

- The ASD-51W does not come with an Ethernet cable.
- For Ethernet cable, we recommend that you use shielded normal type cable. If you use flat type or a non-shielded cable, the noise may adversely affect other devices.

**❑ Computer**

A computer with the following specifications is required to use a music server:

- OS  
Windows® XP Service Pack2 or later, Windows Vista
- Software (Prepare one of the following.)
  - Windows Media Player ver.11
  - DLNA-compatible server software
- Internet browser  
Microsoft Internet Explorer 6 or later
- LAN port
- 300 MB or more free disk space

※ Free disk space is required to store music and video files. The following sizes are approximate.

Format	Bit rate	Per minute	Per hour
MP3 / WMA MPEG-4 AAC	128 kbps	Approx. 1 MB	Approx. 60 MB
	192 kbps	Approx. 1.5 MB	Approx. 90 MB
	256 kbps	Approx. 2 MB	Approx. 120 MB
WAV (LPCM)	392 kbps	Approx. 3 MB	Approx. 180 MB
	1400 kbps	Approx. 10 MB	Approx. 600 MB
FLAC	1080 kbps	Approx. 7.7 MB	Approx. 464 MB



For connections to the Internet, contact an ISP (Internet Service Provider) or a computer shop.

**NOTE**

- A contract with an ISP is required to connect to the Internet.  
No additional contract is needed if you already have a broadband connection to the Internet.
  - The types of routers that can be used depend on the ISP. Contact an ISP or a computer shop for details.
  - Depending on the server, video files may be displayed, but they cannot be played on the ASD-51W.
- ❑ Others**
- If you have an Internet provider contract for a line on which network settings are made manually, make the settings at GUI menu "Setup" – "Network" – "Network Setup" (☞ page 11).
  - With the ASD-51W, it is possible to use the DHCP and Auto IP functions to make the network settings automatically.
  - When using a broadband router (DHCP function), the ASD-51W sets the IP address, etc., automatically.  
When using the ASD-51W connected to a network with no DHCP function, make the settings for the IP address, etc., at GUI menu "Setup" – "Network" – "Network Setup" (☞ page 11).
  - The ASD-51W is not compatible with PPPoE. A PPPoE-compatible router is required if you have a contract for a line of the type with which the PPPoE is set.
  - Depending on the ISP with which you have your contract, it may be necessary to make proxy server settings to use the Internet radio function. If you made proxy server settings on the computer to connect to the Internet, make the proxy server settings on the ASD-51W in the same way.



# Settings

## GUI Menu Map

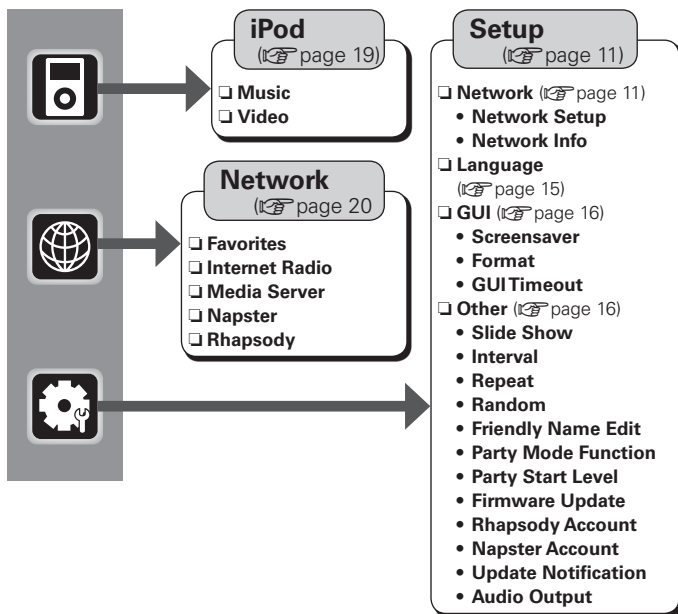

## GUI Menu Operations

With the ASD-51W, settings and operations for most functions can be performed by operating while looking at the GUI menus displayed on the monitor screen.

### 1 Press TOP MENU.

The GUI menu is displayed on the monitor screen.

### 2 Press $\Delta$ / $\nabla$ to select the menu to be set or operated.

※ To return to the previous item, press  $\triangleleft$ .

### 3 Press ENTER or $\triangleright$ to enter the setting.

#### □ Exiting the GUI Menu

Press **TOP MENU** while the GUI menu is displayed.  
The GUI menu display disappears.

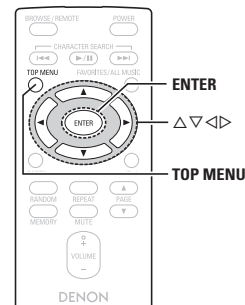

## Example of the Display of the GUI Mark at a Title

Items for which this mark is indicated at the title can be operated from the GUI.  
We recommend performing such operations from the GUI.



## Making Detailed Settings (Setup)

**GUI**

This is the GUI icon for this setting item or for the menu series to which this item belongs.

GUI Menu Operations

Examples of GUI Screen Displays

Some typical examples are described below.

Example: Browse Menu (Top Menu)

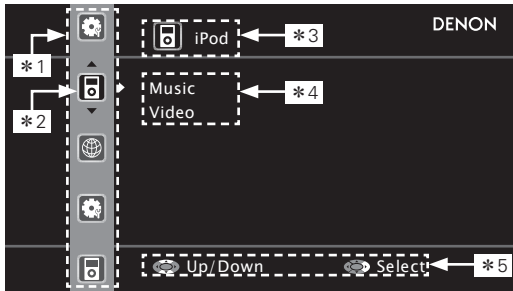

Press  $\nabla$  to select "Globe" and then press  $\triangleright$  (or press ENTER.).

- \* 1 : List GUI menu setup icons
- \* 2 : Currently selected setup icon
- \* 3 : Currently selected setup item
- \* 4 : List of currently selected setup items
- \* 5 : Operation button guidance

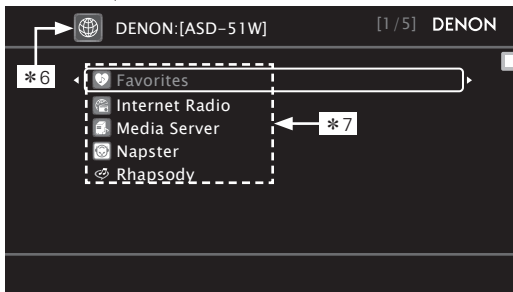

- \* 6 : Selected setup icon
- \* 7 : Options of the selected setup item

Icon

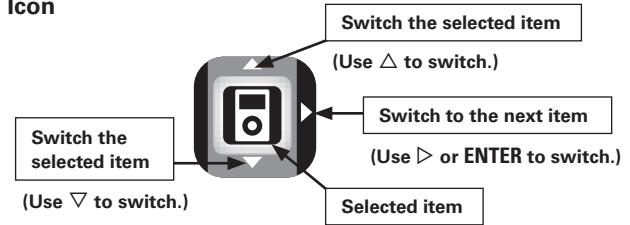

List

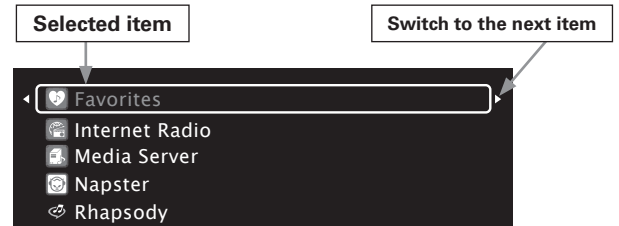

- ※ Switch the selected item using  $\Delta$ / $\nabla$ .
- ※ By using the **PAGE**  $\Delta$ / $\nabla$  button, the list page may be sent / returned.



## Making Detailed Settings (Setup) GUI

For details on how to select, set and cancel settings for each menu, see “GUI Menu Operation” (☞ page 9, 10).

### Items that can be set with the “Setup” procedure

#### Making the network settings (Network)

##### Wired LAN settings

☞ page 11

##### Wireless LAN settings

###### Automatic settings

☞ page 13

###### WPS settings

☞ page 14

###### Manual settings

☞ page 15

#### Making language settings (Language) ☞ page 15

#### Making the GUI settings (GUI) ☞ page 16

#### Making other settings (Other) ☞ page 16

## Making the Network Settings (Network) GUI

Default settings are underlined.

Make network settings.

Setting items	Setting contents
<b>Network Setup</b> Make settings for wired or wireless LAN.	<div style="border: 1px solid black; border-radius: 10px; padding: 5px; margin-bottom: 10px;"> <input type="checkbox"/> <b>Wired LAN settings</b> </div> <ol style="list-style-type: none"> <li>1. <b>Connect the LAN cable</b> (☞ page 7).</li> <li>2. <b>Turn on the ASD-51W</b> (☞ page 4, 6 ※1).                      ASD-51W performs automatic network setup due to the DHCP function.                      When connecting to a network that has no DHCP function, perform the setting in step 3.</li> <li>3. <b>Set the IP address at the GUI menu “Setup” – “Network” – “Network Setup”.</b></li> </ol>



Setting items	Setting contents
<b>Network Setup</b> (Continued)	<p> <input type="checkbox"/> Network Setup <span style="float: right;">DENON</span>                      DHCP ON                      IP Address 192.168.11.3                      Exit                      Detail                      Up/Down                 </p> <p>                     • If you are using a broadband router (DHCP function), there is no need to make the settings at “IP Address” and “Proxy”, since the DHCP function is set to “ON” in the ASD-51W’s default settings.                      • If the ASD-51W is being used connected to a network without the DHCP function, the network settings must be made. In this case, some knowledge of networks is required. For details, consult a network administrator.                 </p> <p>                     ① Select “Detail” and press <b>ENTER</b>.                      ② Use <b>▷</b> to set “DHCP” to “OFF”, then press <b>▽</b>. The DHCP function is disabled.                      ③ Use <b>△▽◀▶</b> to input the address and press <b>ENTER</b>.                 </p> <p>                     • <b>IP Address</b> : Set the IP address within the ranges shown below. The Network Audio function cannot be used if other IP addresses are set.                      CLASS A : 10.0.0.0 ~ 10.255.255.255                      CLASS B : 172.16.0.0 ~ 172.31.255.255                      CLASS C : 192.168.0.0 ~ 192.168.255.255                 </p> <p>                     • <b>Subnet Mask</b> : When connecting an xDSL modem or terminal adapter directly to the ASD-51W, input the subnet mask indicated in the documentation supplied by your provider. Normally input 255.255.255.0.                 </p> <p>                     • <b>Default Gateway</b> : When connected to a gateway (router), input its IP address.                 </p>
	<p> <input type="checkbox"/> Detail <span style="float: right;">DENON</span>                      DHCP OFF                      IP Address 192.168.11.3                      Subnet Mask 255.255.255.0                      Default Gateway 000.000.000.000                      Primary DNS 000.000.000.000                      Secondary DNS 000.000.000.000                      Proxy                      Up/Down Back/Select                 </p>





### DHCP (Dynamic Host Configuration Protocol)

These are systems by which the IP address and other network settings are automatically set for the ASD-51W, computer, broadband router and network devices.

See overleaf

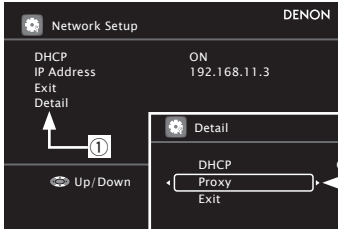
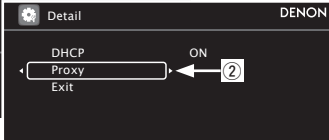
Making Detailed Settings (Setup)	
Setting items	Setting contents
<b>Network Setup</b> (Continued)	<ul style="list-style-type: none"> <li>• <b>Primary DNS / Secondary DNS</b> : If there is only one DNS address indicated in the documentation supplied by your provider, input it at "Primary DNS". If there are two or more DNS addresses, input the first one at "Secondary DNS".</li> <li>④ Use <math>\nabla</math> to select "Exit" and press <b>ENTER</b>. Setup is complete.</li> <li>※ When connecting to the network via a Proxy server, select "Proxy" and press <b>ENTER</b> (☞ page 12 "Proxy settings").</li> </ul>  <ul style="list-style-type: none"> <li>• If you cannot connect to the Internet, recheck the connections and settings (☞ page 7).</li> <li>• If you do not understand about Internet connection, contact your ISP (Internet Service Provider) or the store from which you purchased your computer.</li> <li>• When you want to cancel the setting during IP address input, press <math>\triangleleft</math>.</li> </ul>  <p><b>DNS (Domain Name System)</b> This is a system for converting the domain names used when browsing Internet sites (for example, "www.denon.jp") into the IP addresses actually used for communications (for example, "202.221.192.106").</p> <ul style="list-style-type: none"> <li>☐ <b>Proxy settings</b> : Make this setting when connecting to the Internet via a proxy server.</li> </ul>

Setting items	Setting contents
<b>Network Setup</b> (Continued)	  <p>① On the GUI menu, select "Setup" – "Network" – "Network Setup" – "Detail" and press <b>ENTER</b>.</p> <p>② Use <math>\triangle \nabla</math> to set "Proxy" and press <b>ENTER</b>.</p> <p>③ Use <math>\triangleright</math> to set "Proxy" to "ON" and press <math>\nabla</math>. The proxy server is enabled.</p> <p>④ Use <math>\triangleright</math> to select "Proxy" (input method), and then press <math>\nabla</math>.</p> <ul style="list-style-type: none"> <li>• <b>Address</b> : Select when inputting by address.</li> <li>• <b>Name</b> : Select when inputting by domain name.</li> </ul> <p>⑤ Use <math>\triangle \nabla \triangleleft \triangleright</math> to input the proxy server address or domain name and press <b>ENTER</b>. When "Address" is selected in step ④ : Input the address. When "Name" is selected in step ④ : Input the domain name. The types of characters that can be input are as shown below.</p> <div style="border: 1px solid black; padding: 5px;"> <p><b>[Lower case characters]</b> a ~ z  <b>[Upper case characters]</b> A ~ Z  <b>[Symbols]</b> ! " # % &amp; ' ( ) * + , - . / : ; &lt; = &gt; ? @ [ \ ] _ (Space)  <b>[Numbers]</b> 0 ~ 9</p> </div>

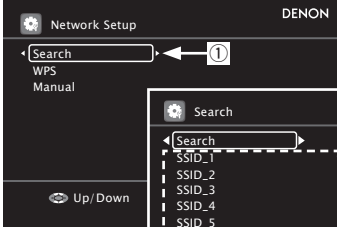
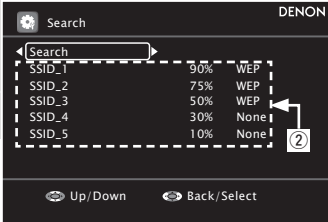
Setting items	Setting contents
<b>Network Setup</b> (Continued)	⑥ Use $\Delta \nabla \triangleleft \triangleright$ to input the proxy server port number and press <b>ENTER</b> . ⑦ Use $\nabla$ to select "Exit" and press <b>ENTER</b> . Setup is complete.
 <p>When searching access points to connect automatically, refer to "Automatic settings".                      When searching access points to connect manually, refer to "Manual settings".                      If the device is connected to a router with a WPS function, please refer to "WPS settings".</p>	<div style="border: 1px solid black; border-radius: 10px; padding: 5px; text-align: center; margin-bottom: 10px;"> <b>Wireless LAN settings</b> </div> <ol style="list-style-type: none"> <li><b>Fitting a rod antenna</b> (☞ page 7).                              ※ If a LAN cable is connected, remove it.</li> <li><b>Turn on the ASD-51W</b> (☞ page 4, 6 ※1 ).</li> <li><b>Set the access point at the GUI menu "Setup" – "Network" – "Network Setup"</b>.</li> </ol> <div style="border: 1px solid black; border-radius: 10px; padding: 5px; text-align: center; margin-bottom: 10px;"> <b>Automatic settings</b> </div>   <p>① Select "Search" and press <b>ENTER</b>.                      The access point you have set is displayed.                      ※ If your preferred access point is not found, repeat step ①.</p>

Making Detailed Settings (Setup)	
Setting items	Setting contents
<b>Network Setup</b> (Continued)	② Use $\Delta \nabla$ to select the access point, and then press <b>ENTER</b> . ※ If the access point is not detected automatically, use the "Manual settings" procedure (☞ page 15). ※ If the access points are repeat search, use $\nabla$ to select the "Search" and press <b>ENTER</b> . ③ If there is an encryption setting for the access point you selected in step ②, enter same encryption key as used for the access point. (If there is no encryption setting, proceed to step ④). • Use $\Delta \nabla \triangleleft \triangleright$ to input the "Key" (encryption key) and press <b>ENTER</b> . Enter the same encryption key as used for the access point. The types of characters that can be input are as shown below.
	<div style="border: 1px solid black; padding: 10px; margin: 10px 0;"> <p><b>[Lower case characters]</b> a ~ z  <b>[Upper case characters]</b> A ~ Z  <b>[Symbols]</b> ! " # % &amp; ' ( ) * + , - . / : ; &lt; = &gt; ? @ [ \ ] _ (Space)  <b>[Numbers]</b> 0 ~ 9</p> </div> <p>※ When no security settings have been used in the Internet connection settings, this step is not necessary.                      ※ When connecting to a "WEP" encrypted network, set the access point "Default Key" to "1".</p> <p>④ Use <math>\nabla</math> to select "Connection" and press <b>ENTER</b>.                      Network connection starts.                      ※ ASD-51W performs automatic network setup due to the DHCP function.                      When connecting to a network that has no DHCP function, perform the setting in step 4.</p> <p><b>4. Set the IP address</b> (☞ page 11 "Wired LAN settings" – step 3 – ③).</p>

➡ See overleaf

## Making Detailed Settings (Setup)

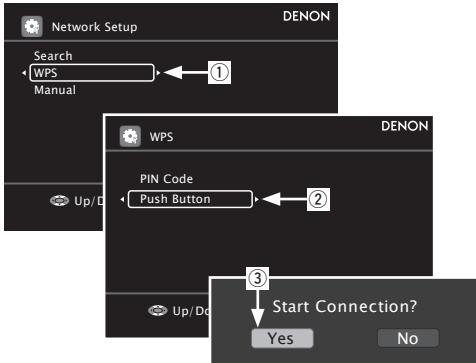
Setting items	Setting contents
<b>Network Setup</b> (Continued)	<div style="text-align: center; border: 1px solid gray; border-radius: 10px; padding: 5px; width: fit-content; margin: 0 auto;"> <b>WPS settings (Push-button method)</b> </div>  <ol style="list-style-type: none"> <li>① Select "WPS" and press <b>ENTER</b>.</li> <li>② Select "Push Button" and press <b>ENTER</b>. "Start Connection?" is displayed.</li> <li>③ Use &lt; &gt; to select "Yes" and press <b>ENTER</b>. "Please press the "WPS" button of target access point" is displayed.</li> <li>④ Press the "WPS" button on the router. When connection is established with access point, "Connection completed" is displayed.</li> </ol>

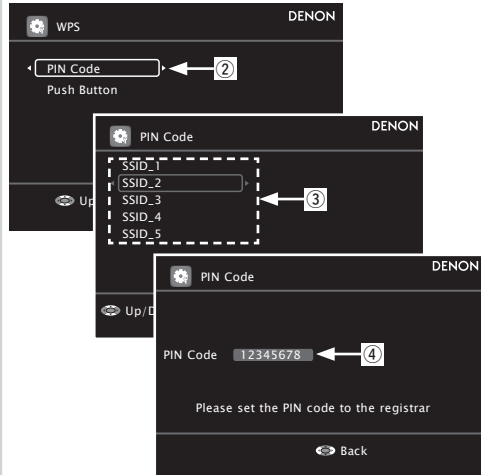
Setting items	Setting contents
<b>Network Setup</b> (Continued)	<div style="text-align: center; border: 1px solid gray; border-radius: 10px; padding: 5px; width: fit-content; margin: 0 auto;"> <b>WPS settings (PIN code method)</b> </div>  <ol style="list-style-type: none"> <li>① Select "WPS" and press <b>ENTER</b>.</li> <li>② Select "PIN Code" and press <b>ENTER</b>. The access point you have set is displayed.</li> <li>③ Use <math>\Delta</math> <math>\nabla</math> to select the access point and press <b>ENTER</b>. PIN code number is displayed.</li> <li>④ Set this PIN code to the registrar. When connection is established with access point, "Connection completed" is displayed.</li> </ol>

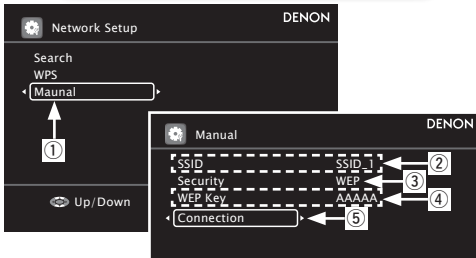
Setting items	Setting contents
<p><b>Network Setup</b> (Continued)</p>  <p>If you are using a router with no DHCP function to automatically assign the IP address, set the IP address manually.</p>	<p style="text-align: center;"><b>Manual settings</b></p>  <p>① Select “Manual” and press <b>ENTER</b>.</p> <p>② Use <math>\Delta \nabla \triangleleft \triangleright</math> to input the name of the wireless network (SSID) and press <b>ENTER</b>. The types of characters that can be input are as shown below.</p> <div style="border: 1px solid black; padding: 5px; margin: 10px 0;"> <p><b>[Lower case characters]</b> a ~ z  <b>[Upper case characters]</b> A ~ Z  <b>[Symbols]</b> ! " # % &amp; ' ( ) * + , - . / : ; &lt; = &gt; ? @ [ \ ] _ (Space)  <b>[Numbers]</b> 0 ~ 9</p> </div> <p>③ Use <math>\Delta \nabla</math> to select “Security” and press <math>\triangleright</math>.</p> <ul style="list-style-type: none"> <li>• <b>None</b> : Select if not encrypted. Can also be used even without encryption, through we recommend encryption for improved security.</li> <li>• <b>WEP / WPA(TKIP) / WPA(AES) / WPA2(TKIP) / WPA2(AES)</b> : Select the encryption method according to the encryption setting of the access point you are using.</li> </ul>

Making Detailed Settings (Setup)	
Setting items	Setting contents
<p><b>Network Setup</b> (Continued)</p>	<p>④ Use <math>\Delta \nabla \triangleleft \triangleright</math> to input the “Key” (encryption key) and press <b>ENTER</b>. Enter the same encryption key as used for the access point.</p> <ul style="list-style-type: none"> <li>※ When no security settings have been used in the Internet connection settings, this step is not necessary.</li> <li>※ When connecting to a “WEP” encrypted network, set the access point “Default Key” to “1”.</li> </ul> <p>⑤ Use <math>\nabla</math> to select “Connection” and press <b>ENTER</b>. Network connection starts.</p> <ul style="list-style-type: none"> <li>※ ASD-51W performs automatic network setup due to the DHCP function. When connecting to a network that has no DHCP function, perform the setting in step 4.</li> </ul> <p><b>4. Set the IP address</b> (☞ page 11 “Wired LAN settings” – step 3 – ③).</p>
<p><b>Network Info</b> Display network information.</p>	<p><b>SSID / DHCP= ON/OFF / IP Address / MAC Address</b></p>

**Making Language Settings (Language)** **GUI**

**Default settings are underlined.**

Set the language for display on the GUI screen.

**Setting contents**

**English / Français / Deutsch / Español / 日本語**

Making Detailed Settings (Setup)

Making the GUI settings (GUI) **GUI**

Default settings are underlined.

Make GUI related settings.

Setting items	Setting contents
<p><b>Screensaver</b> Make screensaver settings. Use the screensaver to prevent burn-in on the monitor screen.</p>	<p><b>ON</b> : When set to "ON", the screensaver is activated if there is no activity for about 3 minutes. <b>OFF</b> : Screen saver is not activated.</p>
<p><b>Format</b> Select the video output signal format to match the monitor.</p>	<p><b>NTSC</b> : Select NTSC output. <b>PAL</b> : Select PAL output. ※ Normally there is no need to set this.</p> <p style="text-align: center;"><b>NOTE</b></p> <p>When a format other than the video format of the connected monitor is set, the picture will not be displayed properly. Use the procedure described below to change the video format.</p> <ul style="list-style-type: none"> <li>Set to NTSC Press and hold <b>TOP MENU</b> and <b>PAGE</b>△ for at least 3 seconds. "NTSC" is set.</li> <li>Set to PAL Press and hold <b>TOP MENU</b> and <b>PAGE</b>▽ for at least 3 seconds. "PAL" is set.</li> </ul>
<p><b>GUI Timeout</b> Set the GUI display time when not operating.</p>	<p><b>Always</b> : Show display continuously. <b>10s</b> : Show display for 10 seconds after operation. <b>30s</b> : Show display for 30 seconds after operation.</p>







Making other settings (Other) **GUI**





Default settings are underlined.

Make various other settings.

Setting items	Setting contents
<p><b>Slide Show</b> Make slideshow settings.</p>	<p><b>OFF</b> : Display only the selected still picture image. <b>ON</b> : Display still picture images in a slide show.</p>
<p><b>Interval</b> Set the playback time per image.</p>	<p><b>5s / 10s / 15s / 20s / 30s / 40s / 60s</b></p>
<p><b>Repeat</b> Make settings for repeat mode.</p>	<p><b>OFF</b> : Disable repeat playback. <b>ALL</b> : Repeat all songs. <b>ONE</b> : Repeat the current song.</p>
<p><b>Random</b> Make settings for shuffle mode.</p>	<p><b>OFF</b> : Disable random playback. <b>Songs</b> : Select songs random. <b>Albums</b> : Select albums random. ※ With network audio, only the Songs Random mode works.</p>
<p><b>Friendly Name Edit</b> The Friendly Name is the name ASD-51W displayed on the network.</p>	<p><b>Edit</b> : Up to 63 characters can be input. The default Friendly Name on first use is "DENON:[ASD-51W]". The types of characters that can be input are as shown below.</p> <div style="border: 1px solid black; padding: 5px; margin: 10px 0;"> <p><b>[Lower case characters]</b> a ~ z <b>[Upper case characters]</b> A ~ Z <b>[Symbols]</b> ! " # % &amp; ' ( ) * + , - . / : ; &lt; = &gt; ? @ [ \ ] _ (Space) <b>[Numbers]</b> 0 ~ 9</p> </div> <p><b>Default</b> : Reset all settings to factory default.</p>



Making Detailed Settings (Setup)		Making Detailed Settings (Setup)	
Setting items	Setting contents	Setting items	Setting contents
<b>Party Mode Function</b> Set the Party Mode function.	<b>ON</b> : Enable Party Mode function. <b>OFF</b> : Disable Party Mode function.  Refer to page 30, "Playing the Same Network Audio on Different Devices Connected in a Network (Party Mode Function)" for more information on the party mode function.	<b>Firmware Update</b> (Continued)	<b>4. While watching the GUI screen, use <math>\Delta \nabla \triangleleft \triangleright</math> to select "Setup" – "Other" – "Firmware Update".</b> ※ When the language setting is "English".  <b>5. Select "Start" and press ENTER.</b> <ul style="list-style-type: none"> <li>When you press <b>ENTER</b>, firmware updating starts automatically.</li> <li>The message "Now Updating. During this process screen will go blank for several minutes. Do not turn off." will appear briefly, after which the GUI screen will go blank.</li> <li>During firmware updating, the power indicator is turned off and the GUI screen is blank.</li> <li>The updating process takes approx. 10 ~ 15 minutes with a broadband connection. The actual time will vary depending on the server status and the speed of the Internet.</li> <li>When updating is complete, the GUI screen reappears automatically.</li> <li>Set the power operation switch on the ASD-51W to "OFF". Firmware updating is now complete.</li> </ul>
<b>Party Start Level</b> Make settings for volume level when the Party Mode is started.	<b>Volume Level</b> <ul style="list-style-type: none"> <li><b>0 ~ 100 %</b> : Start party mode with your preferred volume.</li> </ul>  This can be set when "Party Mode Function" is set to "ON".	<div style="border: 1px solid black; border-radius: 10px; padding: 2px; display: inline-block;"><b>NOTE</b></div> <p><b>When you update the firmware your settings will be returned to the default values. Please be aware that updating the firmware will erase all your settings, including the stations registered in your Favourites and your Recently Played list.</b></p> <p><b>[How to update the firmware]</b></p> <ol style="list-style-type: none"> <li><b>Connect the monitor and connect to the network.</b>   page 6</li> <li><b>Turn on the ASD-51W</b> ( page 4, 6 ※1 ).</li> <li><b>Configure the network connection settings.</b>   page 7</li> </ol>	<div style="border: 1px solid black; border-radius: 10px; padding: 2px; display: inline-block;"><b>NOTE</b></div> <p>Step <b>5</b> cannot take place if the ASD-51W does not connect to the Internet. In this case, repeat the procedure from step <b>2</b>.</p>  If your ASD-51W already has the latest firmware version, the message "Latest Firmware" will appear at step <b>5</b> . In this case, you do not need to update the firmware.
<b>Firmware Update</b> Update the firmware.	<b>Check for Update</b> : You can update to the latest firmware by connecting the ASD-51W to a network. It is recommended that you update to the latest firmware version when using the ASD-51W.		

Making Detailed Settings (Setup)			
Setting items	Setting contents	Setting items	Setting contents
<b>Rhapsody Account</b> Set or change Username and Password (page 26 "Listening to Rhapsody" (for North America model only)).	<b>Username / Password</b> The types of characters that can be input are as shown below. <div style="border: 1px solid black; padding: 5px; margin: 5px 0;">                         [Lower case characters] a ~ z                          [Upper case characters] A ~ Z                          [Symbols] ! " # % &amp; ' ( ) * + , - . / : ; &lt; = &gt; ? @ [ \ ] _ (Space)                          [Numbers] 0 ~ 9                     </div>  The password may not contain underscores ( _ ).	<b>Update Notification</b> Displays a notification message on the ASD-51W's GUI screen when the latest firmware is released with "Firmware Update". The notification message is displayed for about 20 seconds when the power is turned on. Connect to broadband Internet (page 7) when using this function.	<b>ON</b> : Display update message. <b>OFF</b> : Do not display update message.  <ul style="list-style-type: none"> <li>When you press <b>ENTER</b> during display of the notification message, the "Check for Update" screen is displayed. (Refer to page 17 for more information on "Firmware Update".)</li> <li>Press <b>RETURN</b> (on the GUI screen) to erase the notification message.</li> </ul>
	<b>Clear</b> : Delete the entered username and password.		
<b>Napster Account</b> Set or change Username and Password (page 24 "Listening to Napster").	<b>Username / Password</b> The types of characters that can be input are as shown below. <div style="border: 1px solid black; padding: 5px; margin: 5px 0;">                         [Lower case characters] a ~ z                          [Upper case characters] A ~ Z                          [Symbols] ! " # % &amp; ' ( ) * + , - . / : ; &lt; = &gt; ? @ [ \ ] _ (Space)                          [Numbers] 0 ~ 9                     </div>  The password may not contain underscores ( _ ).	<b>Analog</b> : Output audio from the analog audio output connectors. <b>Digital</b> : Output audio from the digital audio output connector.  When "Audio Output" is set to "Digital", the remote control's <b>VOLUME</b> and <b>MUTE</b> buttons do not operate.	
	<b>Clear</b> : Delete the entered username and password.		

# Playback

## iPod® Playback

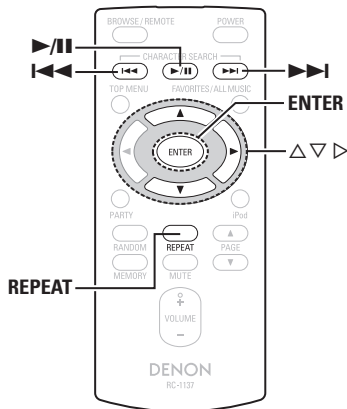

“Made for iPod” means that an electronic accessory has been designed to connect specifically to iPod and has been certified by the developer to meet Apple performance standards.

Apple is not responsible for the operation of this device or its compliance with safety and regulatory standards.

iPod is a trademark of Apple Inc., registered in the U.S. and other countries.

※ The iPod may only be used to copy or play contents that are not copyrighted or contents for which copying or playback is legally permitted for your private use as an individual. Be sure to comply with applicable copyright legislation.

### Preparations

#### Load the iPod onto the ASD-51W.

① Set the iPod in the ASD-51W.



(iPod screen)

※ If the screens above are not displayed, the iPod may not be properly connected. Try connecting again.

#### NOTE

- Depending on the type of iPod and the software version, some functions may not operate.
- DENON will accept no responsibility whatsoever for any loss of iPod data.

### Playback Music and Video

- 1 Use  $\Delta$   $\nabla$  to select “iPod”, then press **ENTER** or  $\triangleright$ .
- 2 Use  $\Delta$   $\nabla$  to select the menu, then press **ENTER** or  $\triangleright$  to select the music or video file to be played.

**3** Press **ENTER**,  $\triangleright$  or **▶/II**  
Playback starts.

#### ❑ Stopping playback temporarily

During playback, press **ENTER** or **▶/II**. Press again to resume playback.

#### ❑ Fast-forwarding or fast-reversing

During playback, either press and hold **I◀◀** or **▶▶I**.

#### ❑ To cue to the beginning of a track

During playback, either press  $\Delta$  (to cue to the previous track) or  $\nabla$  (to cue to the next track), or press **I◀◀** or **▶▶I**.

#### ❑ To stop

During playback, either press and hold **ENTER**.

#### ❑ Playing repeatedly

Press **REPEAT** to switch the repeat mode.

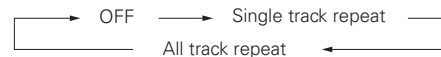

**GUI** : “Setup” – “Other” – “Repeat”  
(page 16)

✎ “TV Out” at the iPod’s “Slideshow Settings” or “Video Settings” must be set to “ON” in order to display the iPod’s photo data or videos on the monitor. For details, see the iPod’s operating instructions.

See overleaf  $\rightarrow$

## iPod® Playback

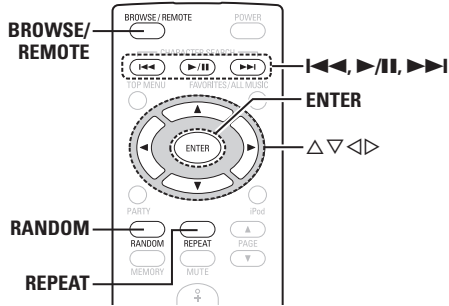
 Shuffling playback

Press **RANDOM** to switch the shuffle mode.



**GUI**: "Setup" – "Other" – "Random"  
(☞ page 16)

**To switch between the Browse and Remote modes**

Either press and hold **BROWSE/REMOTE**.

 Browse mode

This mode is for operating by displaying the iPod information on the monitor connected to the ASD-51W.

In this mode, it is not possible to operate the iPod directly or to perform the operations associated with the slide show function. Set the Remote mode to play slide shows.

 Remote mode

This mode is for operating the iPod directly while watching the information displayed on the iPod's screen.

In this mode, the GUI operation guide is not displayed on the monitor.

**Viewing Still Pictures on the iPod**

Photo data on the iPod can be viewed on the monitor.

- 1 Press and hold BROWSE/REMOTE to set the Remote mode.**
- 2 Use  $\Delta$   $\nabla$  to select the menu, then press ENTER or  $\triangleright$  to select the file to be played.**
- 3 Press ENTER,  $\triangleright$  or  $\blacktriangleright$ /II until the image you want to view is displayed.**

 "TV Out" at the iPod's "Slideshow Settings" or "Video Settings" must be set to "ON" in order to display the iPod's photo data or videos on the monitor. For details, see the iPod's operating instructions.

**Playing Network Audio**

This procedure can be used to play Internet radio stations or music or still picture (JPEG) files stored on a computer.

**About the Internet Radio Function**

- Internet radio refers to radio broadcasts distributed over the Internet. Internet radio stations from around the world can be tuned in. The ASD-51W is equipped with the following Internet radio functions:
  - Stations can be selected by genre and region.
  - Internet radio stations in MP3 and WMA (Windows Media Audio) format can be listened to.
  - Your favorite radio stations can be registered by accessing an exclusive DENON Internet radio URL from a Web browser on a computer.
    - The function is managed for individual users, so you must provide your MAC or e-mail address. Exclusive URL: <http://www.radiodenon.com>
- The ASD-51W's Internet radio station list is created using a radio station database service (vTuner). This database service provides a list edited and created for the ASD-51W.
  - The radio station database service may be suspended without notice.

**Media Player**

This function lets you play music files and playlists (m3u, wpl) stored on a computer (Media server) connected to the ASD-51W via a network. With the ASD-51W's network audio playback function, connection to the server is possible using one of the technologies below.

- Windows Media Player Network Sharing Service
- Windows Media DRM10

## ❑ Album art function

When a WMA (Windows Media Audio), MP3 or MPEG-4 AAC file includes album art data, the album art can be displayed while the music files are playing.

 For music files in WMA (Windows Media Audio) format, the album art is only played when using Windows Media Player ver. 11.

## ❑ Slide show function

Still picture (JPEG) files stored in folders on a music server can be played as slide shows.

The time for which each picture is displayed can be set.

 When still picture (JPEG) files are played on the ASD-51W, they are played in the direction in which they are stored in the folder, so store in them in the direction in which you want them to play.

### Installing Windows Media Player ver. 11

- ① If Windows XP Service Pack 2 has not yet been installed, either download it free of charge from Microsoft or install it via a Windows update installer.
  - ② Download the latest version of Windows Media Player ver. 11, either directly from Microsoft or using a Windows update installer.
- ※ When using Windows Vista, there is no need to download a new version of Windows Media Player.

### [Compatible formats]

	Internet radio	Media server ※
<b>WMA</b> (Windows Media Audio)	○	○
<b>MP3</b> (MPEG-1 Audio Layer-3)	○	○
<b>WAV</b>	-	○
<b>MPEG-4 AAC</b>	-	○*
<b>FLAC</b> (Free Lossless Audio Codec)	-	○
<b>JPEG</b>	-	○

A server or server software compatible with distribution in the corresponding formats is required to play music files via a network.

- \*: Only files that are not protected by copyright can be played on the ASD-51W.  
 Contents downloaded from pay sites on the Internet are copyright protected. Also, files encoded in WMA format when ripped from a CD, etc., on a computer may be copyright protected, depending on the computer's settings.
- ※ The ASD-51W is compatible with MP3 ID3-Tag (Ver. 2) standards.  
 ※ The ASD-51W is compatible with WMA META tags.  
 ※ WAV format Quantization bit rate: 16 bits.

### [Playable formats]

	Sampling frequency	Bit rate	Extension
<b>WMA</b> (Windows Media Audio)	32/44.1/48 kHz	48~192 kbps	.wma
<b>MP3</b> (MPEG-1 Audio Layer-3)	32/44.1/48 kHz	32~320 kbps	.mp3
<b>WAV</b>	32/44.1/48 kHz	-	.wav
<b>MPEG-4 AAC</b>	32/44.1/48 kHz	16~320 kbps	.aac/.m4a/.mp4
<b>FLAC</b> (Free Lossless Audio Codec)	32/44.1/48 kHz	-	.flac

## Napster

Napster is a monthly subscription music distribution service provided by Napster. This service allows users to download and play pieces of music they want to hear on the ASD-51W. Before you can use Napster, you will need to visit the Napster website on your PC to create an account and register as a member. For details, access the following site:

[http://www.napster.com/choose/index\\_default.html](http://www.napster.com/choose/index_default.html)

## Rhapsody

Rhapsody is a paid music broadcast service of Real Networks.

When you first listen to Rhapsody, it is necessary to subscribe to a Rhapsody account at the Rhapsody homepage by your PC and register this machine. See the Rhapsody homepage for details.

[www.rhapsody.com/denon](http://www.rhapsody.com/denon)



## Clearing Internet Radio Stations from Your Favorites

- 1 Use  $\triangle$   $\nabla$  to select “Favorites”, then press **ENTER** or  $\triangleright$ .
- 2 Use  $\triangle$   $\nabla$  to select the Internet radio station you want to clear, then press **MEMORY**.
- 3 Press  $\triangleleft$  to select “Remove”.  
The selected Internet radio station is cleared. To cancel the operation without clearing the station, press  $\triangleright$ .

 Pressing **FAVORITES** also displays the favorites folder.

## Playing Files Stored on a Computer

Use this procedure to play music files, image files or playlists.

### 1 Playback preparation.

- ① Check the network environment, then turn on the ASD-51W's power. (🔧 page 7 “Connecting to a Home Network (LAN)”)
- ② If settings are required, make the network settings. (🔧 page 11 ~ 15 “Network Setup”)
- ③ Prepare the computer. (🔧 Computer's operating instructions)  
Install “Windows Media Player ver. 11”.

- 2 Use  $\triangle$   $\nabla$  to select “Network”, then press **ENTER** or  $\triangleright$ .
- 3 Use  $\triangle$   $\nabla$  to select the host name of the computer on which the media file you want to play is located, then press **ENTER** or  $\triangleright$ .
- 4 Use  $\triangle$   $\nabla$  to select the search item or folder, then press **ENTER** or  $\triangleright$ .  
A “📁” mark is indicated in front of music files that can be played, and a “🖼️” mark is indicated in front of image files that can be played.
- 5 Use  $\triangle$   $\nabla$  to select the file, then press **ENTER** or  $\triangleright$ .  
Playback starts.



- Connections to the required system and specific settings must be made in order to play music files (🔧 page 7).
- Before starting, you must launch the computer's server software and set the files as server contents. For details, see the operating instructions of your server software.
- Depending on the size of the still picture (JPEG) file, some time may be required for the file to be displayed.

### ❑ Stopping playback temporarily

During playback, press **ENTER** or **▶/II**. Press again to resume playback.

### ❑ To stop

(🔧 page 19)

### ❑ Searching pages

(🔧 page 10)

### ❑ Selecting tracks

During playback, either press  $\Delta$ ,  $\blacktriangleleft$  (previous track) or  $\nabla$ ,  $\blacktriangleright$  (next track).

### ❑ Playing repeatedly

Press **REPEAT** to switch the repeat mode.

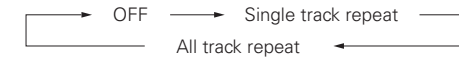

### ❑ Playing in random order

Press **RANDOM** to switch the random mode.



## Playing files that have been Registered in Your Favorites

Files can be registered in your favorites and played using the same operations as for Internet radio stations.

### NOTE

- When the operation described below is performed, the media server's database is updated and it may no longer be possible to play preset or favorite music files.
- When you quit the media server and then restart it.
- When music files are deleted or added on the media server.
- When using an ESCIENT server, please “ESCIENT” before the server name. (North America only)

Playing Network Audio

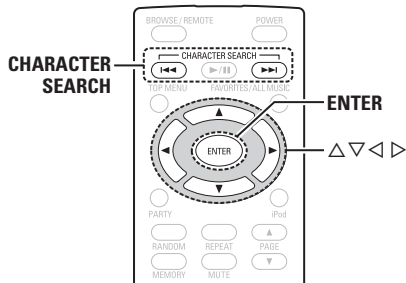

Listening to Napster

1 Playback preparation.

- ① Check the network environment, then turn on the ASD-51W's power. (☞ page 7 "Connecting to a Home Network (LAN)")
- ② If settings are required, make the network settings. (☞ page 11 ~ 15 "Network Setup")

2 Use Δ ∇ to select "Network", then press ENTER or ▷.

3 Use Δ ∇ to select "Napster", then press ENTER or ▷.

4 Use Δ ∇ ▷ to input "Username" and "Password".

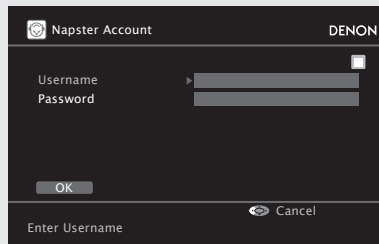

5 After inputting the "Username" and "Password", select "OK", then press ENTER.

If the "Username" and "Password" match, the top menu for Napster is displayed.

- Username : \_\_\_\_\_
  - Password : \_\_\_\_\_
- [Input characters]

[Lower case characters] a ~ z  
 [Upper case characters] A ~ Z  
 [Symbols] ! " # % & ' ( ) \* + , - . / : ; < = > ? @  
 [ ] \ \_ (Space)  
 [Numbers] 0 ~ 9

NOTE

The password may not contain underscores ( \_ ).

Search From Napster Menu

1 Use Δ ∇ to select search item or folder, then press ENTER or ▷.

2 Use Δ ∇ to select the track item, then press ENTER or ▷.

Enter a Character Search For the Track You Want to Listen to

1 Press CHARACTER SEARCH.

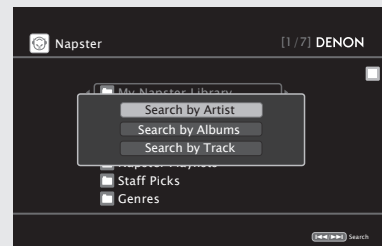

※ You can search by artist name, album name or track name.



- 2** Use  $\triangle$   $\nabla$  to select the search item, then press **ENTER**.

The search display appears.

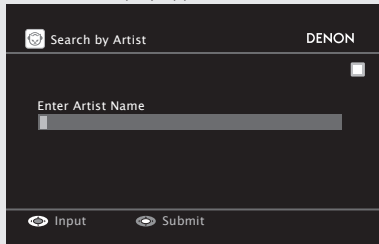

- 3** Enter the characters, then press **ENTER**.

## Registering Tracks in My Napster Library

- 1** Press  $\triangleright$  while the track you wish to register is playing.

- 2** Select “Add to My Napster Library”, then press **ENTER** or  $\triangleright$ .  
The track is entered in the Library.

### Listening to Tracks Registered In My Napster Library

- 1** Use  $\triangle$   $\nabla$  to select “My Napster Library”, then press **ENTER** or  $\triangleright$ .

- 2** Use  $\triangle$   $\nabla$  to select the information or track, then press **ENTER**.  
After selecting, the information is displayed.

- To stop** (🔊 page 19)
- Selecting tracks** (🔊 page 23)
- Playing repeatedly** (🔊 page 19)
- Playing in random order** (🔊 page 23)

Playing Network Audio

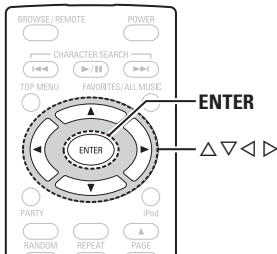

**Listening to Rhapsody (for North America model only)**

**1 Playback preparation.**

- ① Check the network environment, then turn on the ASD-51W's power. (☞ page 7 "Connecting to a Home Network (LAN)")
- ② If settings are required, make the network settings. (☞ page 11 ~ 15 "Network Setup")

**2** Use  $\Delta \nabla$  to select "Network", then press **ENTER** or  $\triangleright$ .

**3** Use  $\Delta \nabla$  to select "Rhapsody", then press **ENTER** or  $\triangleright$ .

**4** Use  $\Delta \nabla$  to select "Sign in to your account", then press **ENTER** or  $\triangleright$ .

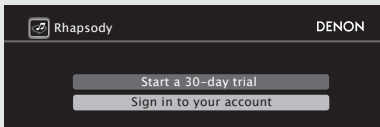

**5** Use  $\Delta \nabla \triangleright$  to input "Username" and "Password".

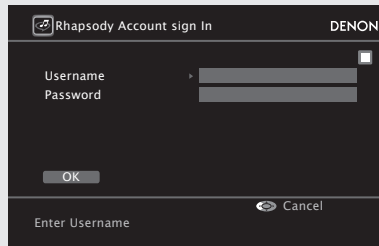

**6** After inputting the "Username" and "Password", select "OK", then press **ENTER**.

If the "Username" and "Password" match, the top menu for Rhapsody is displayed.

- Username : \_\_\_\_\_
  - Password : \_\_\_\_\_
- [Input characters]

[Lower case characters] a ~ z  
 [Upper case characters] A ~ Z  
 [Symbols] ! " # % & ' ( ) \* + , - . / : ; < = > ? @  
 [ \ ] \_ (Space)  
 [Numbers] 0 ~ 9

**NOTE**

- The password should be no longer than 99 characters.
- The password may not contain underscores ( \_ ).

Select the Search Mode

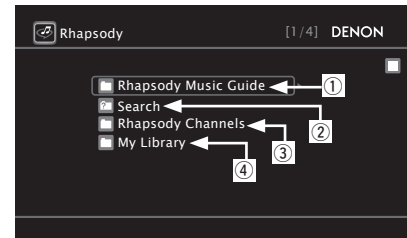

**① Search From Rhapsody Latest Information**

**1** Use  $\Delta \nabla$  to select "Rhapsody Music Guide", then press **ENTER** or  $\triangleright$ .

**2** Use  $\Delta \nabla$  to select the information for track selection, then press **ENTER** or  $\triangleright$ .  
 After selecting, the information is displayed.

**3** Use  $\Delta \nabla$  to select the track, then press **ENTER** or  $\triangleright$ .

## ② Enter a Character Search For the Track You Want to Listen to

**1** Use  $\Delta$ / $\nabla$  to select “Search”, then press **ENTER** or  $\triangleright$ .

**2** Use  $\Delta$   $\nabla$  to select the search item, then press **ENTER** or  $\triangleright$ .

The search display appears.

※ You can search by artist name, album name, track name or keyword.

**3** Enter the characters, then press **ENTER**.

## ③ Search From the Rhapsody Internet Radio Station

**1** Use  $\Delta$ / $\nabla$  to select “Rhapsody Channels”, then press **ENTER** or  $\triangleright$ .

**2** Use  $\Delta$   $\nabla$  to select radio station, then press **ENTER** or  $\triangleright$ .

## ④ Listening to Tracks Registered In My Library

**1** Use  $\Delta$ / $\nabla$  to select “My Library”, then press **ENTER** or  $\triangleright$ .

**2** Use  $\Delta$   $\nabla$  to select the information or track, then press **ENTER** or  $\triangleright$ .

After selecting, the information is displayed.

## Track Menu

Press  $\triangleright$  during playback to display the Track Menu.

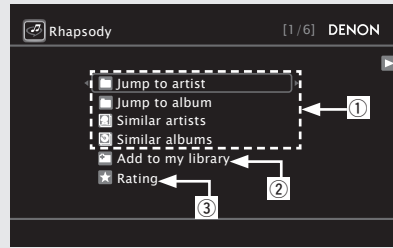

### ① Search From the Similar Music

Use  $\Delta$ / $\nabla$  to select the search item, then press **ENTER** or  $\triangleright$ .

### ② Registering Tracks in My Library

Use  $\Delta$ / $\nabla$  to select “Add to My Library”, then press **ENTER** or  $\triangleright$ .

The track is entered in the Library.

### ③ Rating Function

**1** Use  $\Delta$ / $\nabla$  to select “Rating”, then press **ENTER** or  $\triangleright$ .

**2** Use  $\triangleleft$   $\triangleright$  to select the rating, then press **ENTER**.

## Convenient Functions

### Operating a Wireless LAN-Compatible Mobile Terminal to Play Music

- Perform this procedure using a wireless LAN-compatible mobile terminal conforming to the DLNA (Digital Living Network Alliance) standard.
- This function allows you to play contents located on a computer (media server) or mobile device connected in a network by operating a mobile device in the same network.
- There are two types of operations on the mobile device.

#### Playing Contents on a Computer (Media Server)

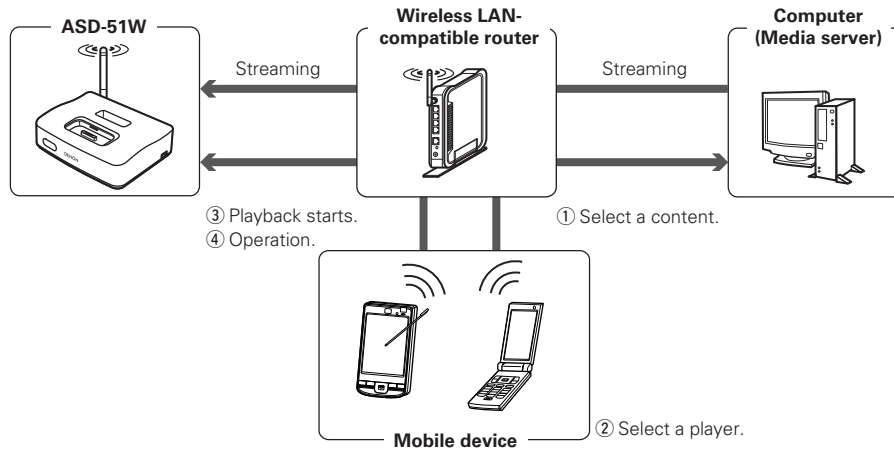

**1** From the mobile device, browse the media server in the same network and choose the contents you want to play.

**2** From the mobile device, select the ASD-51W among the products in the network.

Playback of the contents selected in step 1 begins.

※ When selecting the ASD-51W from the mobile device, the name of the ASD-51W is displayed at "Friendly Name" (☞ page 16 "Friendly Name Edit").

※ The following operations are possible from the mobile device:

- File operations (play, stop, pause, track search)
- Play mode settings (repeat/random)
- Volume adjustment

## Playing Contents on a Mobile device

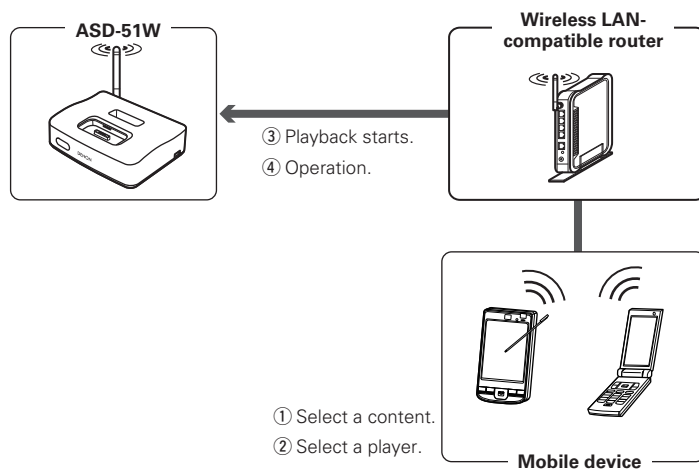

**1** Select the contents you want to play from among the mobile devices.

**2** From the mobile device, select the ASD-51W among the products in the network.

Playback of the contents selected in step 1 begins.

※ When selecting the ASD-51W from the mobile device, the name of the ASD-51W is displayed at "Friendly Name" (page 16 "Friendly Name Edit").

※ The following operations are possible from the mobile device:

- File operations (play, stop, pause, track search)
- Play mode settings (repeat/random)
- Volume adjustment



- " " is displayed on the GUI screen while the mobile device is being operated.
- For the various settings and operating procedures, see the operating instructions of the mobile devices being used.
- When selecting the ASD-51W from the mobile device, the name of the ASD-51W is displayed at "Friendly Name: "Friendly Name" can be edited at "Friendly Name Edit" (page 16) as desired so that it is easily distinguishable from other devices.

### NOTE

When operations related to browsing or playback (play, stop, pause, track search) are performed on the ASD-51W while operating the mobile device, the connection to the network is disconnected. The network connection is also disconnected when the party mode is started.

## Convenient Functions

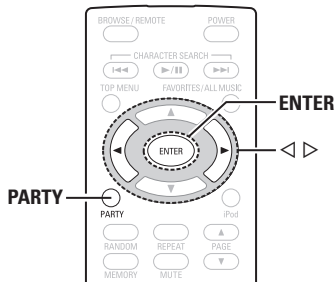

### Playing the Same Network Audio on Different Devices Connected in a Network (Party Mode Function)

The same network audio (Internet Radio, Media Server or iPod music file) can be played on multiple DENON products equipped with the Party Mode function and connected in a network.

The party mode consists of one organizer and up to four attendees. When one unit starts the party mode as the organizer, up to four devices on which the party mode function is activated automatically participate in the party as attendees. "Party Mode Function" (page 17) must be set to "ON" ahead of time in order to use the party mode function.

#### NOTE

If the ASD-51W is coupled with the DENON AVR-3310 or AVR-4310 AV receiver, when using the party mode function you should first update the AVR-3310 or AVR-4310 to the latest firmware.

See the AV receiver's instruction manual for information on how to perform the firmware update.

### Starting the Party Mode as the Organizer

**1 Press PARTY to become the organizer.**  
"Enter Party Mode?" is displayed.

※ An error message is displayed when you are not connected to a network.

**2 Press  $\triangleleft$   $\triangleright$  to select "Yes", then press ENTER.**

The PARTY mode indicator on the front panel lights up green, and the attendees are automatically selected.

**3 Play the desired track.**

#### □ To Cancel the Party Mode

**1 While in the party mode, press PARTY.**

"Exit Party Mode?" is displayed.

**2 Press  $\triangleleft$   $\triangleright$  to select "Yes", then press ENTER.**

"Power off Attendees component?" is displayed.

**3 Press  $\triangleleft$   $\triangleright$  to select "Yes" or "No", then press ENTER.**

**Yes** : The power of the attendees is turned off and the party mode is canceled.

**No** : The party mode is canceled without turning off the power of the attendees.

### Starting the Party Mode as the Attendee

- When the organizer starts the party mode, up to four attendees are selected automatically. No operation is required.
- When you become an attendee, the PARTY mode indicator on the front panel lights up orange, and you are able to enjoy the same network audio as the organizer.
- If there are fewer than four attendees, a device can join the party mode after it has started. To participate in the party mode, perform the operation described below.

**1 Press PARTY.**  
"Enter Party Mode?" is displayed.

※ An error message is displayed when you are not connected to a network.

**2 Press  $\triangleleft$   $\triangleright$  to select "Yes", then press ENTER.**

## □ To Cancel the Party Mode

**1** While in the party mode, press **PARTY**.

“Exit Party Mode?” is displayed.

**2** Press ◀ ▶ to select “Yes”, then press **ENTER**.

In this case, the other devices remain in the party mode.

 “Rhapsody” and “Napster” are not available in the Party Mode.

There can only be one organizer in the network. To form a new party mode, first cancel the current party mode.

## Operating the ASD-51W with a Browser (Web Control Function) [iPod touch only]

You can operate the ASD-51W using a browser.

**1** Check the ASD-51W’s IP address with “Network Info” (☞ page 11).

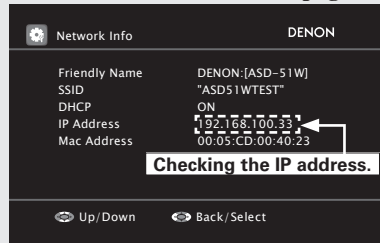

**2** Enter the ASD-51W IP address in browser’s address box.

For example, if the IP address of ASD-51W is “192.168.100.33”, enter “http://192.168.100.33”

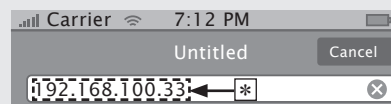

\*: Entering the IP address.

## Convenient Functions

**3** Operate.

※ When accessed from the iPod touch browser, an optimized operation screen is displayed.

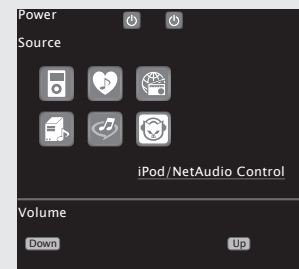

(Dedicated iPod touch screen)

## Other Information

### About Networks

#### Windows Media Player Ver.11

This is a media player distributed free of charge by Microsoft Corporation.

It can be used to play playlists created with Windows Media Player Ver. 11 as well as files in such formats as WMA, DRM WMA, MP3 and WAV.

#### vTuner

This is a free online contents server for Internet radio. For inquiries about this service, visit the vTuner site below.

vTuner website: <http://www.radiodnon.com>

This product is protected by certain intellectual property rights of Nothing Else Matters Software and BridgeCo. Use or distribution of such technology outside of this product is prohibited without a license from Nothing Else Matters Software and BridgeCo or an authorized subsidiary.

#### DLNA

- DLNA and DLNA CERTIFIED are trademarks and/or service marks of Digital Living Network Alliance.
- Some contents may not be compatible with other DLNA CERTIFIED™ products.

#### Windows Media DRM

A copyright-protected technology developed by Microsoft.

Content providers are using the digital rights management technology for Windows Media contained in this device (WM-DRM) to protect the integrity of their content (Secure Content) so that their intellectual property, including copyright, in such content is not misappropriated. This device uses WM-DRM software to play Secure Content (WM-DRM Software). If the security of the WM-DRM Software in this device has been compromised, owners of Secure Content (Secure Content Owners) may request that Microsoft revoke the WM-DRM Software's right to acquire new licenses to copy, display and/or play Secure Content. Revocation does not alter the WM-DRM Software's ability to play unprotected content. A list of revoked WM-DRM Software is sent to your device whenever you download a license for Secure Content from the Internet or from a PC. Microsoft may, in conjunction with such license, also download revocation list onto your device on behalf of Secure Content Owners.

#### About Wireless LAN

##### Wi-Fi®

Wi-Fi Certification assures tested and proven interoperability by the Wi-Fi Alliance, a group certifying interoperability among wireless LAN devices.

##### IEEE 802.11b

This is one wireless LAN standard set by the 802 working group that establishes LAN technology standards at the IEEE (Institute of Electrical and Electronics Engineers) of the United States. It uses the 2.4 GHz band usable freely without a radio frequency license (ISM band), enabling communications at a maximum speed of 11 Mbps.



The value indicated above is the maximum theoretical value for the wireless LAN standard, and does not indicate the actual data transfer rate.

##### IEEE 802.11g

This is another wireless LAN standard set by the 802 working group that establishes LAN technology standards at the IEEE (Institute of Electrical and Electronics Engineers) of the United States, and is compatible with IEEE 802.11b. It also uses the 2.4 GHz band, but enables communications at a maximum speed of 54 Mbps.



The value indicated above is the maximum theoretical value for the wireless LAN standard, and does not indicate the actual data transfer rate.



## **Infrastructure Communications**

“Infrastructure Communications” refers to networks using wireless LAN access points.

This function can be used to connect to the Internet or a wired LAN via a wireless LAN access point. Wireless LAN access points include wireless broadband routers.

### **Network Names**

#### **(SSID: Security Set Identifier)**

When forming wireless LAN networks, groups are formed to prevent interference, data theft, etc. This grouping is done by “SSID” or “Security Set Identifiers”. For further security, a WEP key is set and signal transfer is not possible unless the SSID and WEP key match.

#### **WEP Key (Network Key)**

This is key information used for encrypting data when conducting data transfer. On the ASD-51W, the same WEP key is used for data encryption and decryption, so the same WEP key must be set on both devices in order for communications to be established between them.

#### **WPS (Wi-Fi Protected Setup)**

This is a standard drawn up by the Wi-Fi Alliance to ease the task of setting up wireless LAN connections and configuring security.

There are two methods: push-button and PIN (Personal Identification Number) code.

## **WPA (Wi-Fi Protected Access)**

This is a security standard established by the Wi-Fi Alliance. In addition to the conventional SSID (network name) and WEP key (network key), it also uses a user identification function and encrypting protocol for stronger security.

### **WPA2 (Wi-Fi Protected Access 2)**

This is a new version of the WPA established by the Wi-Fi Alliance, compatible with more secure AES encryption.

### **WPA-PSK/WPA2-PSK (Pre-shared Key)**

This is a simple authentication system for mutual authentication when a preset character string matches on the wireless LAN access point and client.

### **Passphrase**

This refers to the code key used for WPA-PSK/WPA2-PSK authentication, a WPA authentication method.

### **TKIP (Temporal Key Integrity Protocol)**

This is a network key used for WPA. The encryption algorithm is RC4, the same as for WEP, but the security level is increased by changing the network key used for encryption for each packet.

### **AES (Advanced Encryption Standard)**

This is a next generation standard encryption method replacing the current DES and 3DES, and because of its high security it is expected to be applied widely to wireless LANs in the future. It uses the “Rijndael” algorithm developed by two Belgian cryptographers to divide the data into blocks of fixed lengths and encrypt each block. It supports data lengths of 128, 192 and 256 bits and key lengths of 128, 192 and 256 bits as well, offering extremely high encryption security.

# Troubleshooting

If a problem should arise, first check the following:

1. Are the connections correct?
2. Is the set being operated as described in the owner's manual?
3. Are the other components operating properly?

If this unit does not operate properly, check the items listed in the table below. Should the problem persist, there may be a malfunction.

In this case, disconnect the power immediately and contact your store of purchase.

## [General]

Symptom	Cause	Countermeasure	Page
No sound is produced. No image appears on the monitor.	<ul style="list-style-type: none"> <li>• The iPod is not playing.</li> <li>• The iPod is not properly connected to the ASD-51W.</li> <li>• The AC adapter is not connected to the ASD-51W or a power outlet. Or the power operation switch on the ASD-51W is not set to "ON/STANDBY".</li> <li>• The AV/Control cable is not properly connected.</li> <li>• The monitor's input selection is not properly set.</li> </ul>	<ul style="list-style-type: none"> <li>• Check that the iPod is playing.</li> <li>• Check that the iPod is properly connected to the ASD-51W's dock connector.</li> <li>• Check the connections.</li> <li>• Set the power operation switch on the ASD-51W to "ON/STANDBY".</li> <li>• Check the connections.</li> <li>• Set the monitor's input selector to the proper position for the connected video input terminal.</li> </ul>	<p>–</p> <p>–</p> <p>6</p> <p>4</p> <p>6</p> <p>–</p>

## [Remote Control Unit]

Symptom	Cause	Countermeasure	Page
Set does not work properly when remote control unit operated.	<ul style="list-style-type: none"> <li>• Battery are worn.</li> <li>• You are operating outside of the specified range.</li> <li>• Obstacle between main unit and remote control unit.</li> <li>• The battery are not inserted in the proper direction, as indicated by the polarity marks in the battery compartment.</li> <li>• The set's remote control sensor is exposed to strong light (direct sunlight, inverter type fluorescent bulb light, etc.).</li> <li>• A mini-plug cable is connected to the REMOTE CONTROL jack.</li> </ul>	<ul style="list-style-type: none"> <li>• Replace with new battery.</li> <li>• Operate within the specified range.</li> <li>• Remove the obstacle.</li> <li>• Insert the battery in the proper direction, following the polarity marks in the battery compartment.</li> <li>• Move the set to a place in which the remote control sensor will not be exposed to strong light.</li> <li>• Remove the mini-plug cable from the REMOTE CONTROL jack.</li> </ul>	<p>3</p> <p>3</p> <p>3</p> <p>3</p> <p>3</p> <p>6</p>

## [NET]

Symptom	Cause	Countermeasure	Page
Internet radio cannot be played.	<ul style="list-style-type: none"> <li>Ethernet cable is not properly connected or network is disconnected.</li> <li>Program is being broadcast in non-compatible format.</li> </ul>	<ul style="list-style-type: none"> <li>Check the connection status.</li> </ul>	7
		<ul style="list-style-type: none"> <li>Only Internet radio programs in MP3 and WMA can be played on this set.</li> <li>Check the computer's or router's firewall settings.</li> <li>Choose a radio station that is currently broadcasting.</li> <li>Check the set's IP address.</li> </ul>	21
Files stored on a computer cannot be played.	<ul style="list-style-type: none"> <li>The computer's or router's firewall is activated.</li> <li>Radio station is not currently broadcasting.</li> <li>IP address is wrong.</li> </ul>	<ul style="list-style-type: none"> <li>Record in a compatible format.</li> </ul>	21
		<ul style="list-style-type: none"> <li>Files that are copyright protected cannot be played on this set.</li> <li>Turn on the power.</li> </ul>	21
Server is not found, or it is not possible to connect to the server.	<ul style="list-style-type: none"> <li>Computer's power is not turned on.</li> </ul>	<ul style="list-style-type: none"> <li>Check the computer's or router's firewall settings.</li> </ul>	-
		<ul style="list-style-type: none"> <li>Turn on the power.</li> <li>Launch the server.</li> <li>Set's IP address is wrong.</li> </ul>	-
Cannot connect to preset or favorite radio stations.	<ul style="list-style-type: none"> <li>The computer's or router's firewall is activated.</li> <li>Computer's power is not turned on.</li> <li>Server is not running.</li> <li>Set's IP address is wrong.</li> </ul>	<ul style="list-style-type: none"> <li>Wait a while before trying again.</li> </ul>	-
		<ul style="list-style-type: none"> <li>It is not possible to connect to radio stations that are no longer in service.</li> <li>When the <b>RESET</b> button is pressed, the settings are initialized and are restored to the default settings.</li> <li>When the firmware has been updated return to default factory settings.</li> </ul>	-
For some radio stations cannot be connected to.	<ul style="list-style-type: none"> <li>Radio station is not currently broadcasting.</li> <li>Radio station is not currently in service.</li> </ul>	<ul style="list-style-type: none"> <li>Wait a while before trying again.</li> </ul>	-
		<ul style="list-style-type: none"> <li>The <b>RESET</b> button was pressed.</li> <li>Firmware has been updated.</li> </ul>	17
Sound is broken during playback.	<ul style="list-style-type: none"> <li>Station is congested or not currently broadcasting.</li> </ul>	<ul style="list-style-type: none"> <li>This is not a malfunction. When playing broadcast data with a high bit rate, the sound may be broken, depending on the communications conditions.</li> </ul>	-
Sound quality is poor or played sound is noisy.	<ul style="list-style-type: none"> <li>Network's signal transfer speed is slow or communications lines or radio station is congested.</li> </ul>	<ul style="list-style-type: none"> <li>Wait a while before trying again.</li> </ul>	-
		<ul style="list-style-type: none"> <li>This is not a malfunction.</li> <li>Release the iPod equalizer settings.</li> </ul>	-

Symptom	Cause	Countermeasure	Page
For some radio stations, "Server Full" or "Connection Down" is displayed and station cannot be connected to.	<ul style="list-style-type: none"> <li>Station is congested or not currently broadcasting.</li> </ul>	<ul style="list-style-type: none"> <li>Wait a while before trying again.</li> </ul>	-
Cannot login to Rhapsody. ("Incorrect Username or Password" is displayed.)	<ul style="list-style-type: none"> <li>Login information is incorrect.</li> </ul>	<ul style="list-style-type: none"> <li>Check if the Username for Rhapsody has been properly entered. Re-enter the Password. (Password is not displayed.) <a href="http://www.rhapsody.com/denon">www.rhapsody.com/denon</a></li> </ul>	26
Cannot login to Napster. ("Incorrect Username or Password" is displayed.)	<ul style="list-style-type: none"> <li>Login information is incorrect.</li> </ul>	<ul style="list-style-type: none"> <li>Check if the Username for Napster has been properly entered. Re-enter the Password. (Password is not displayed.) <a href="http://www.napster.com/choose/index_default.html">http://www.napster.com/choose/index_default.html</a></li> </ul>	24

**[Wireless LAN]**

Symptom	Cause	Countermeasure	Page
Cannot connect to network.	<ul style="list-style-type: none"> <li>The settings of the SSID and network key (WEP) are incorrect.</li> <li>The reception is poor and the signals cannot be received.</li> </ul>	<ul style="list-style-type: none"> <li>Match the network settings with the ASD-51W's settings.</li> </ul>	11 ~ 15
	<ul style="list-style-type: none"> <li>There are multiple networks and the usable channels overlap.</li> </ul>	<ul style="list-style-type: none"> <li>Shorten the distance from the wireless LAN's access point, remove any obstacles and otherwise improve visibility, then try reconnecting. Also install away from microwave ovens and the access points of other networks.</li> </ul>	-
	<ul style="list-style-type: none"> <li>The router power is off.</li> </ul>	<ul style="list-style-type: none"> <li>Set the access point's channel settings away from the channels used for other networks. Alternatively, connect using a network cable.</li> <li>Turn on the router power.</li> </ul>	-
Played sound is interrupted or sound cannot be played.	<ul style="list-style-type: none"> <li>There are multiple networks and the usable channels overlap.</li> </ul>	<ul style="list-style-type: none"> <li>Set the access point's channel settings away from the channels used for other networks. Alternatively, connect using a network cable.</li> </ul>	-

## Restart and Reset Operations

If a fault occurs during use of the ASD-51W, for example, if you cannot connect to a network although the network settings are correct, or the iPod cannot be detected or the remote control unit does not work, you may be able to resolve the problem by taking the following action.

❑ **Turn the power operation switch on the ASD-51W's side panel to "OFF", and after about 30 seconds turn the power operation switch to "ON/STANDBY": (restart operation)**

❑ **Reset the ASD-51W**

Use the reset operation when you want to restore the default settings or when the restart operation has failed to resolve a fault.

### NOTE

**When you reset the ASD-51W, your settings will be returned to the default values. Please be aware that resetting the ASD-51W will erase all your settings, including the stations registered in your Favourites and your Recently Played list.**

### [How to reset the ASD-51W]

**Insert a thin, pointed object (\*2) into the reset hole (\*1) and press the reset button inside the ASD-51W.**

- The ASD-51W will restart automatically. The GUI screen will appear and the reset operation will be complete.

※To press the reset button inside the ASD-51W use a thin, pointed object such as a toothpick or an unfolded paper clip.

Diameter: 0.8 mm ~ 2.5 mm

Length: 25 mm or more

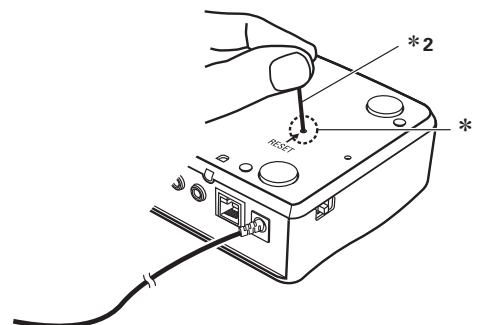

# Specifications

## Control Dock for iPod

**Power supply:** DC IN 6V

**Maximum external dimensions:**

140 (W) x 40 (H) x 110 (D) mm  
(5-33/64" x 1-37/64" x 4-21/64")

**Weight:** 320 g (11.3 oz)

**Terminal:** Analog audio output connectors x 1,  
Digital audio output connector x 1,  
S-Video output connector x 1,  
Dock Control jack x 1  
Remote Control jack x 1  
Ethernet connector x 1  
Wireless antenna terminal x 1

## AC Adapter (KSAFC0600150W1UV-1)

**Rated voltage:** 100 – 240 V, 50/60 Hz

**Rated current:** 0.3 A

## Wireless LAN

**Network type (wireless LAN standards) :**

Conforming to IEEE 802.11b  
Conforming to IEEE 802.11g  
(Conforming to Wi-Fi®)\*

**Transfer rate:** DS-SS: 11 / 5.5 / 2 / 1 Mbps (Automatic switching)  
OFDM: 54/48/36/24/18/12/9/6 Mbps  
(Automatic switching)

**Security:** SSID (Network name)  
WEP key (network key) (64/128 bits)  
WPA-PSK (TKIP/AES)  
WPA2-PSK (TKIP/AES)

**Used frequency range:**

2,412 MHz ~ 2,472 MHz

**No. of channels:** Conforming to IEEE 802.11b :  
11ch (for North America),  
13ch (for Europe) (DS-SS) (Of which 1 channel used)  
Conforming to IEEE 802.11g :  
11ch (for North America),  
13ch (for Europe) (OFDM) (Of which 1 channel used)

## Remote control unit (RC-1137)

**Battery:** CR2025 Type

**Maximum external dimensions:**

42.5 (W) x 100 (H) x 12 (D) mm  
(1-43/64" x 3-15/16" x 15/32")

**Weight:** 35 g (Approx 1.2 oz) (including batteries)

\*: Wi-Fi® conformity indicates tested and proven interoperability by the "Wi-Fi Alliance", a group certifying interoperability among wireless LAN devices.

※For purposes of improvement, specifications and design are subject to change without notice.

**DENON**

[www.denon.com](http://www.denon.com)

D&M Holdings Inc.  
Printed in China 5411 10379 104D